

The CIMA logo is written in a stylized, red, italicized font with a registered trademark symbol (®) at the end. A small Union Jack flag is located in the top right corner of the page.

**cima**®

ATOMIZZATORI-IMPOLVERATORI

## ***New Plus 42-45***



**ATOMIZZATORI PNEUMATICI A BASSO VOLUME  
PNEUMATIC LOW VOLUME SPRAYERS**

# Atomizzatori - Sprayers



☆ Ampia scelta di testate di distribuzione, tutte dotate del nuovo sistema anti-sgocciolamento (brev.N°1745689) e di dispositivi di diffusione (mani e/o cannoni) di diverse dimensioni, **adattabili in altezza, orientabili ed intercambiabili** per garantire, su tutte le tipologie di colture, un'eccellente copertura e penetrazione nella vegetazione.



☆ Broad range of sprayheads, all equipped with the new anti-drip system (patent Nr.1745689). Sprayheads' distribution devices (hands or cannons) are available in different sizes and heights, they can be **adjustable and interchangeable** to guarantee a better spray penetration through the canopy and a complete coverage on any type of crop.

☆ **Regolatori a disco rotante** con 15 fori calibrati (brev.N°23238), sostituiscono il sistema a pastiglie. **Erogazione da 70 a 3400 litri/ora**

☆ **Rotating calibration discs**, 15 positions (patent Nr. 23238), very easy to adjust : **delivery from 70 to 3400 l/h**



☆ **Trasmissione a cinghia poly-V** che assorbe le sollecitazioni. **Funzionamento per oltre 5000 ore.** Il tenditore automatico evita lo slittamento e quindi l'usura. La qualità della polverizzazione resta inalterata nel tempo.

☆ **Ruota libera di sicurezza** per arresto improvviso.

☆ **Poly-V belt drive**, to absorb any stress. **Long life belt - over 5000 hours.** The automatic tensioner keeps tension constant on the belt, avoiding slipping and wear. High quality spray atomization after several years of use.



☆ **Overrunning clutch - Safety stop device** in the event the PTO is suddenly stopped.

☆ Serbatoio in polietilene rotazionale, apertura di riempimento di grandi dimensioni (ø360) con coperchio a cerniera, indicatore di livello.

☆ Serbatoio lavamani integrato l.15.

☆ Serbatoio lavaimpianto integrato nel serbatoio principale (versioni GOLD).

☆ **Idromiscelatore integrato nel filtro a tazza.**

☆ **Doppia agitazione, idraulica e pneumatica.**

Lavamani  
Hand-washing tank

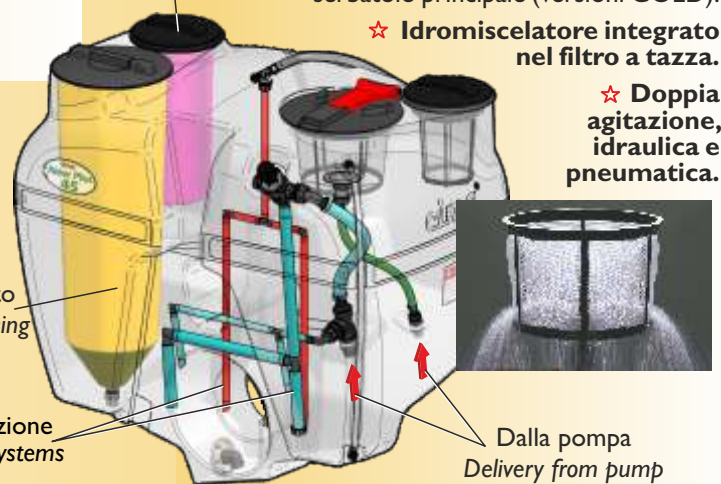

Lavaimpianto  
Spray-line rinsing tank



Dalla pompa  
Delivery from pump

☆ Polyethylene tank. Large filling opening (ø360) with hinged lid and graduated level indicator.

☆ 15 litres fresh water tank included.

☆ Spray-line rinsing tank integrated into the main tank (GOLD models).

☆ Hydraulic pre-mixer incorporated within the basket filter.

☆ Two agitation systems, liquid and air.



# New Plus 42 - 45



- ★ Telaio in acciaio, verniciatura elettrostatica con polvere poliestere e predisposto per applicare coppia ruote.
- ★ Cerchio di protezione delle testate.
- ★ Ventola centrifuga chiusa ad alta pressione, in acciaio, con disinnesto; carter in polietilene rotazionale.
- ★ Controllo dal posto operatore dell'erogazione con due elettrovalvole.



- ★ Steel frame, electrostatic painted with polyester powder and designed for installing optional support wheels.
- ★ Sprayhead bumper guard.
- ★ Steel high pressure radial fan (fan clutch in option), polyethylene fan housing.
- ★ Spraying ON/OFF control by remote control electro-valves from tractor seat.



- ★ Regolatore di pressione manuale (a comando elettrico dal posto operatore a richiesta).
- ★ Manometro (ø100) ben visibile dal posto operatore.
- ★ Filtro di grande portata: 240 l/min.



- ★ Pressure regulator with manual control (optional electro-control from tractor seat).



- ★ 100 mm pressure gauge, clearly visible from tractor seat.
- ★ Large capacity delivery filter: 240 l/min.

- ★ La pompa centrifuga di fabbricazione C.I.M.A. (senza membrane e valvole) costruita in materiale anticorrosivo è esente da manutenzione. La cinghia di trasmissione 3V è dotata di tenditore automatico.



- ★ C.I.M.A.'s centrifugal pump (no diaphragms or valves), is made of anticorrosive material and **does not require any maintenance**. The pump is driven by a 3-V belt equipped with an automatic tensioner.

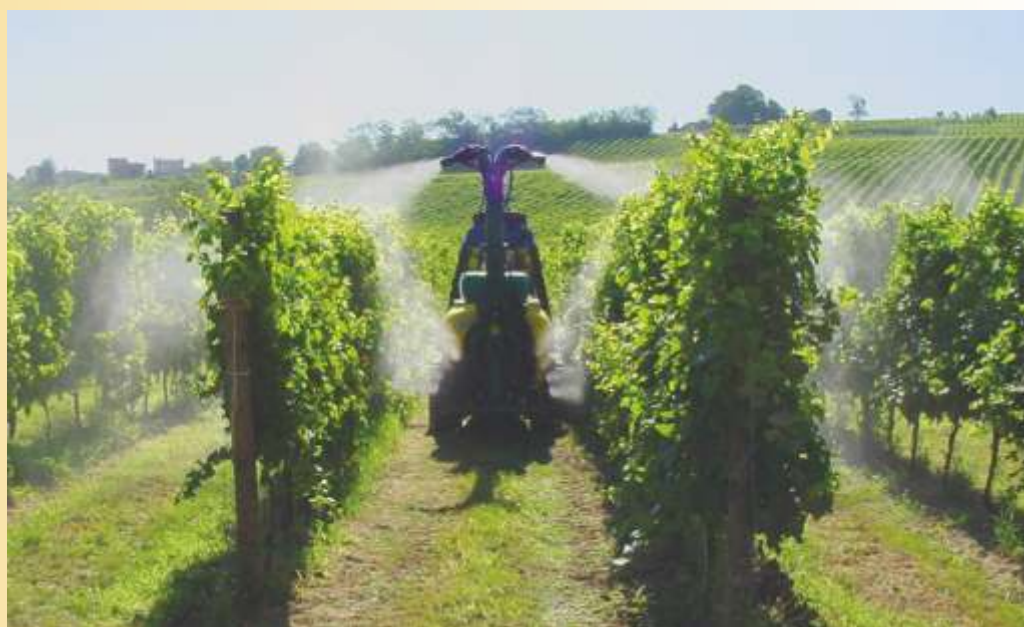

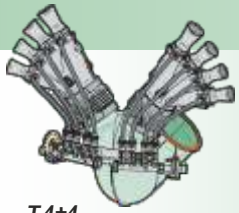
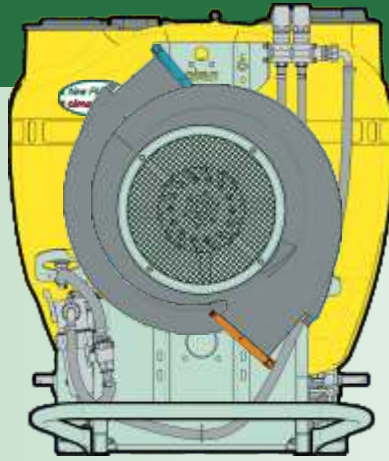

**T.4+4**  
N.Plus 42 (T.4+4.42P)  
N.Plus 45 (T.4+4.45P)

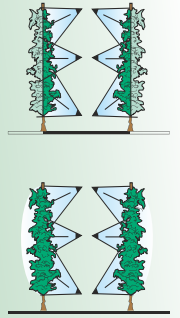
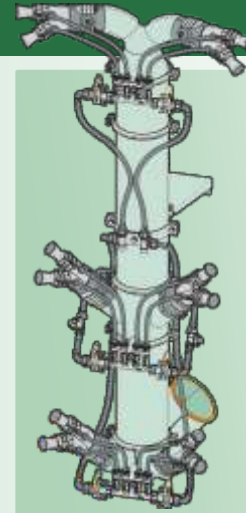
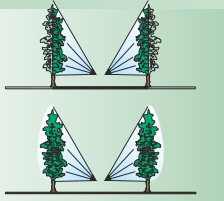

**T.6M**  
N.Plus 42 (T.6M2D.42P)  
N.Plus 45 (T.6M2D.45P)

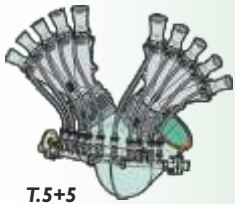

**T.5+5**  
N.Plus 42 (T.5+5.42P)  
N.Plus 45 (T.5+5.45P)

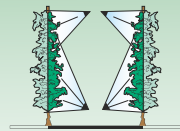
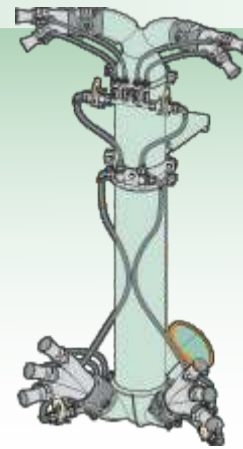
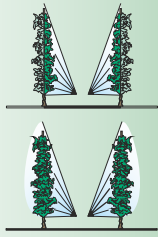

**T.4M**  
N.Plus 42 (T.4M.42P)  
N.Plus 45 (T.4M.45P)

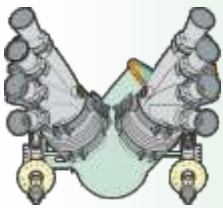

**STRASBURGO - STRASBOURG**  
N.Plus 42 (T.ST4.42P)  
N.Plus 45 (T.ST4.45P)

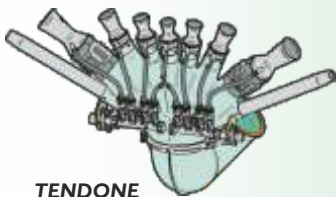
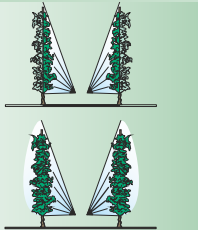

**TENDONE**  
N.Plus 42 (T.TND.42P)  
N.Plus 45 (T.TND.45P)

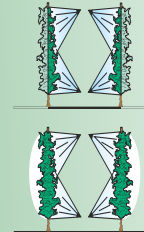
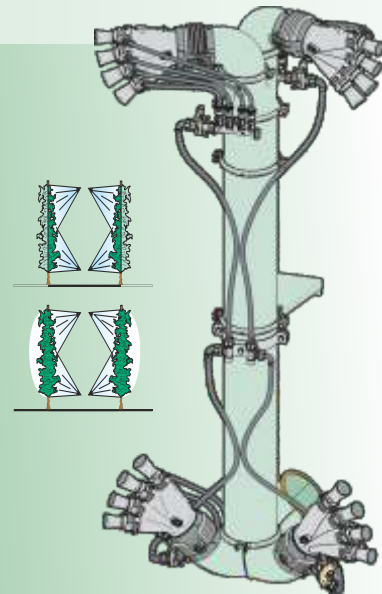
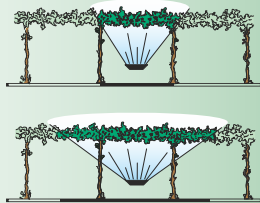

**TC.2M2M**  
N.Plus 45 (TC.2M2M.45P)



**2 VENTAGLI - 2 FISHTAILS**  
N.Plus 42-45 (T.2V3S.45P)

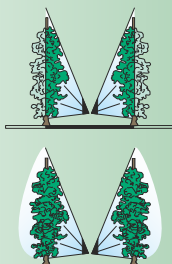



# TESTATE -

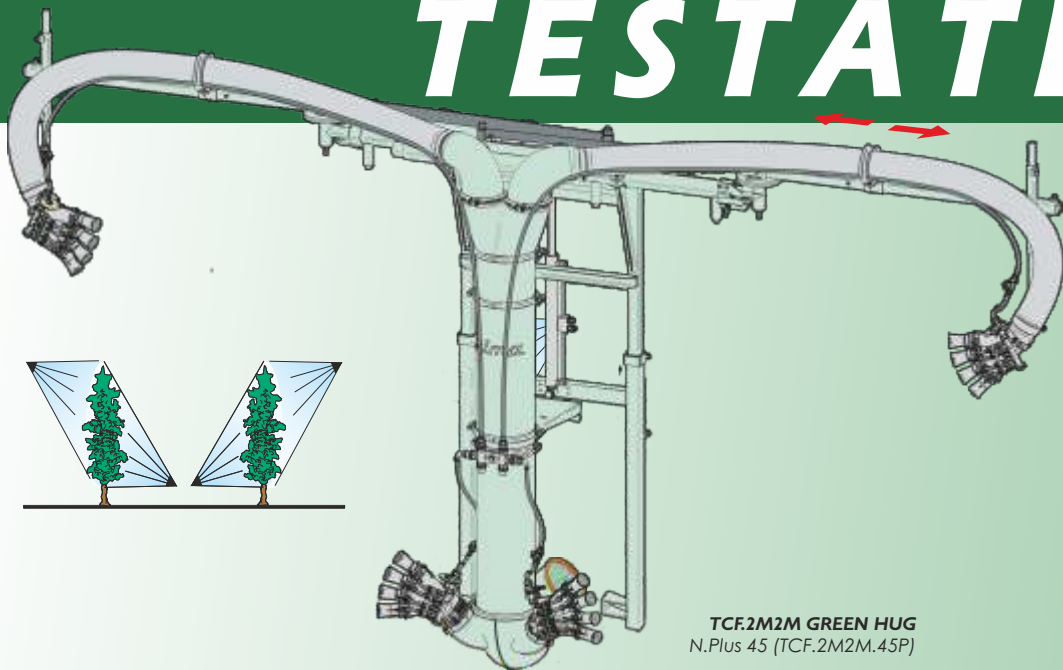

**TCF.2M2M GREEN HUG**  
N.Plus 45 (TCF.2M2M.45P)

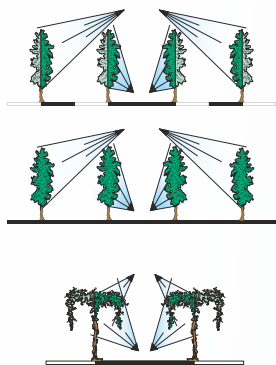

**TC.2M2C**  
N.Plus 45 (TC.2M2C.45P)

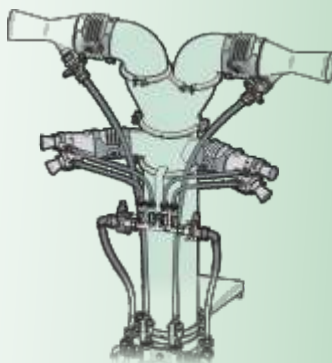
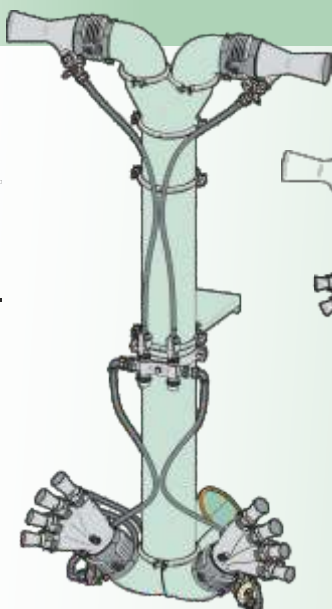

**TC.4M2C**  
N.Plus 45 (TC.4M2C.45P)

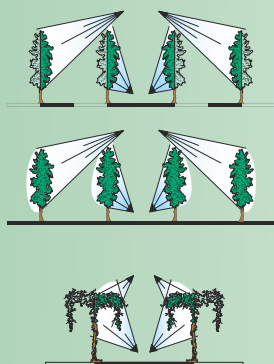
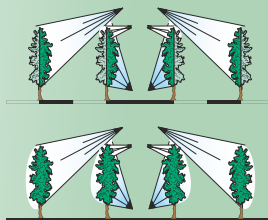

**TCS.2M2C**  
N.Plus 45 (TCS.2M2C.45P)

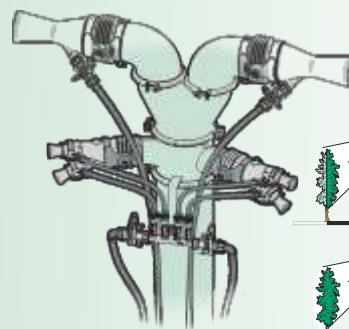
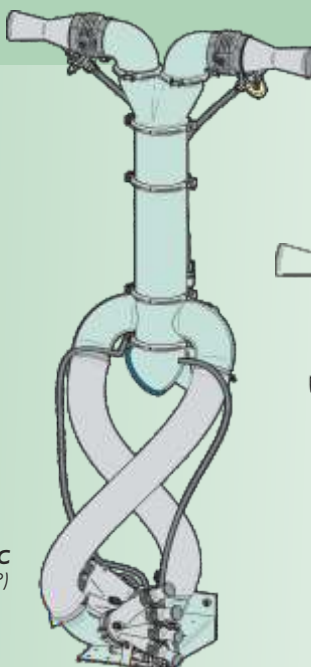

**TCS.4M2C**  
N.Plus 45 (TCS.4M2C.45P)

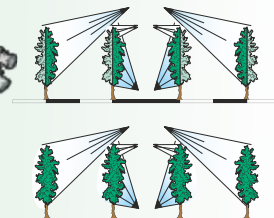

# SPRAYHEADS

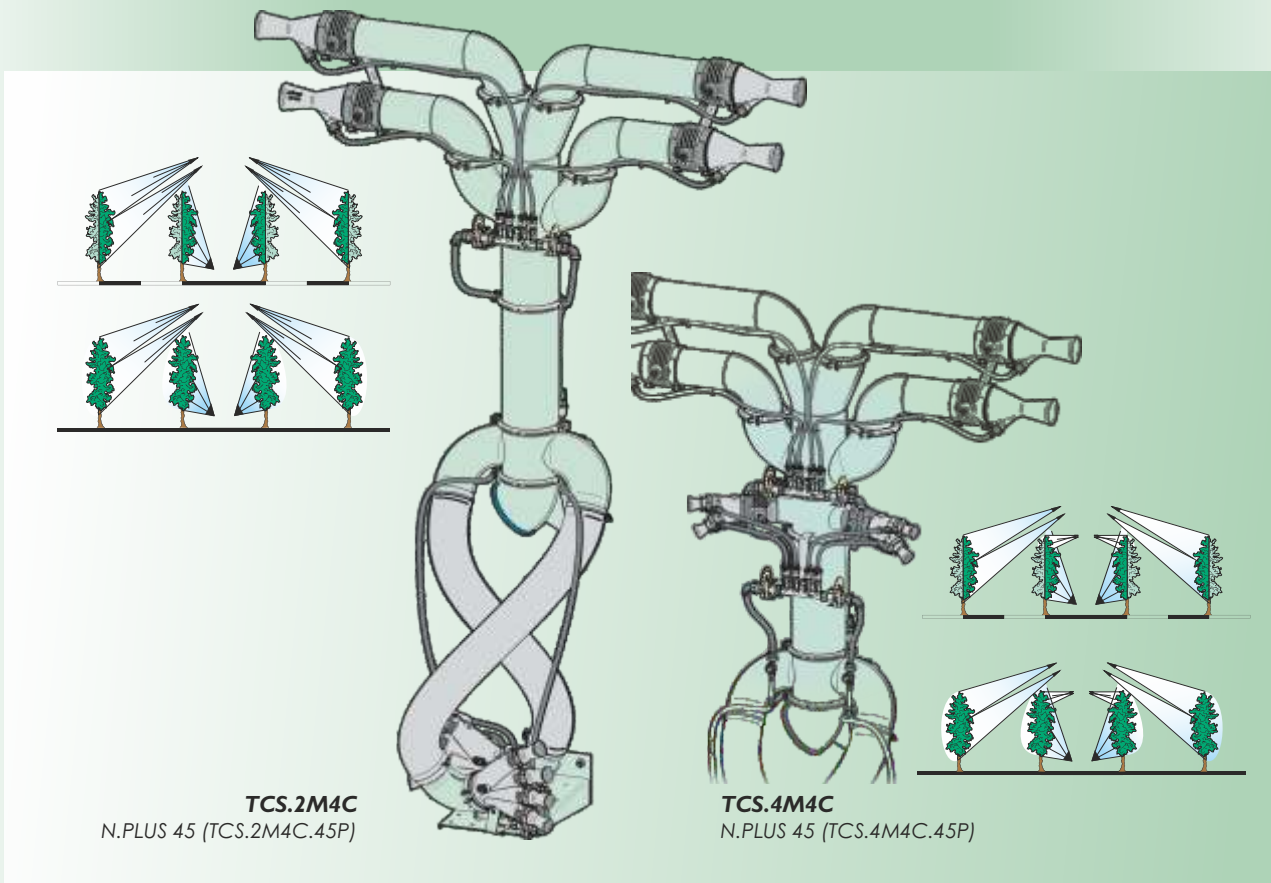
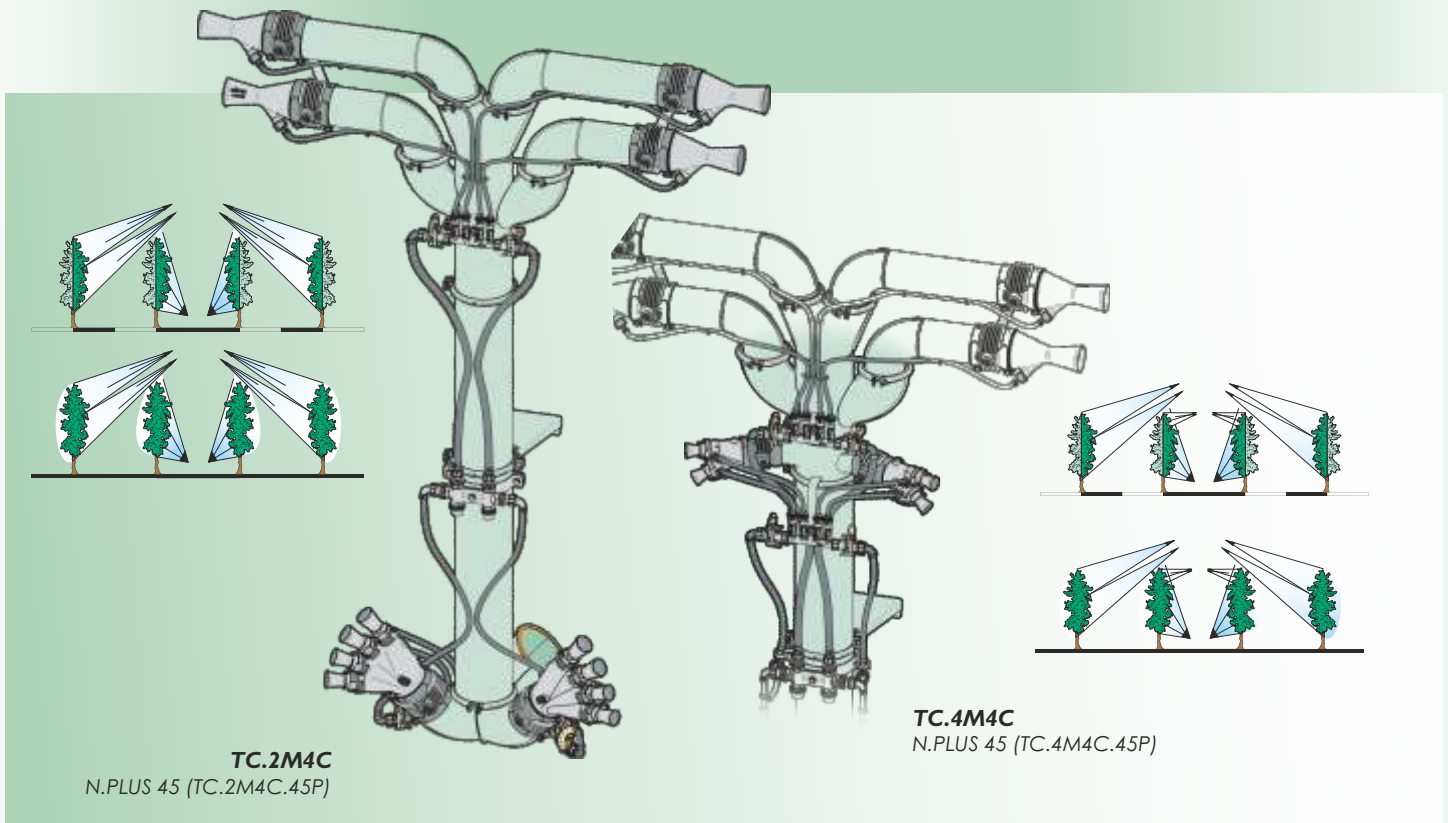

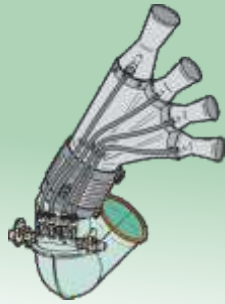

**OLIVO - OLIVE**  
 N.Plus 42 (T.OL.42P)  
 N.Plus 45 (T.OL.45P)

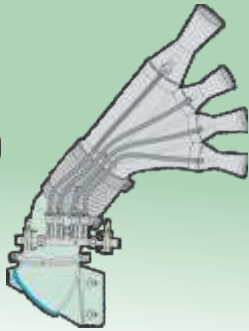

**OLIVO - OLIVE**  
 N.Plus 42 (T.OL.045.42)  
 N.Plus 45 (T.OL.045.45)

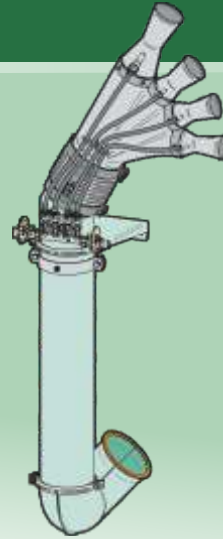
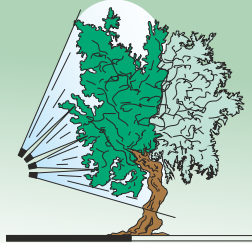

**OLIVO - OLIVE**  
 N.Plus 42 (T.OL.P08.42)  
 N.Plus 45 (T.OL.P08.45)

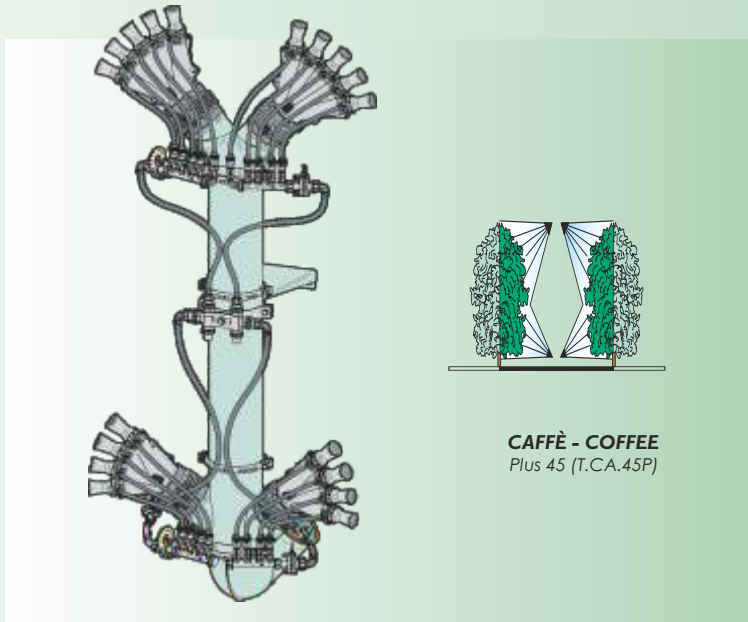
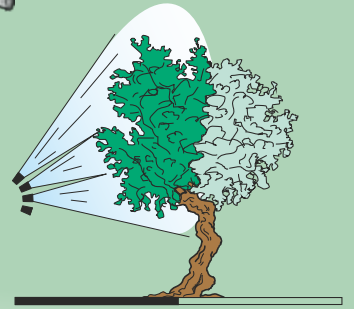

**CAFFÈ - COFFEE**  
 Plus 45 (T.CA.45P)

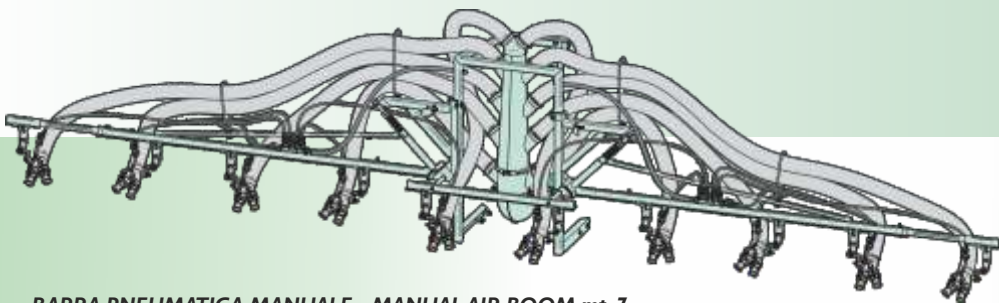

**BARRA PNEUMATICA MANUALE - MANUAL AIR BOOM mt. 7**  
 N.Plus 45 (BM10.2.66.45)

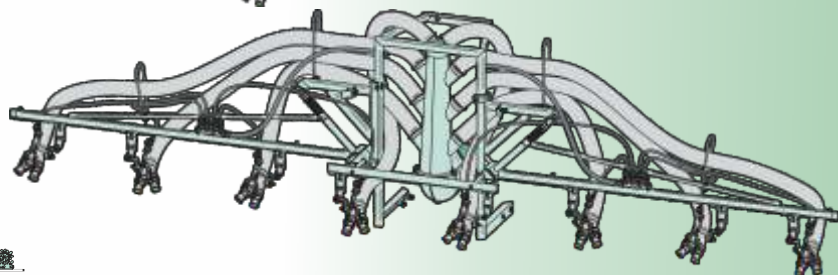

**BARRA PNEUMATICA MANUALE - MANUAL AIR BOOM mt. 5**  
 N.Plus 42 (BM08.2.66.42)  
 N.Plus 45 (BM08.2.66.45)





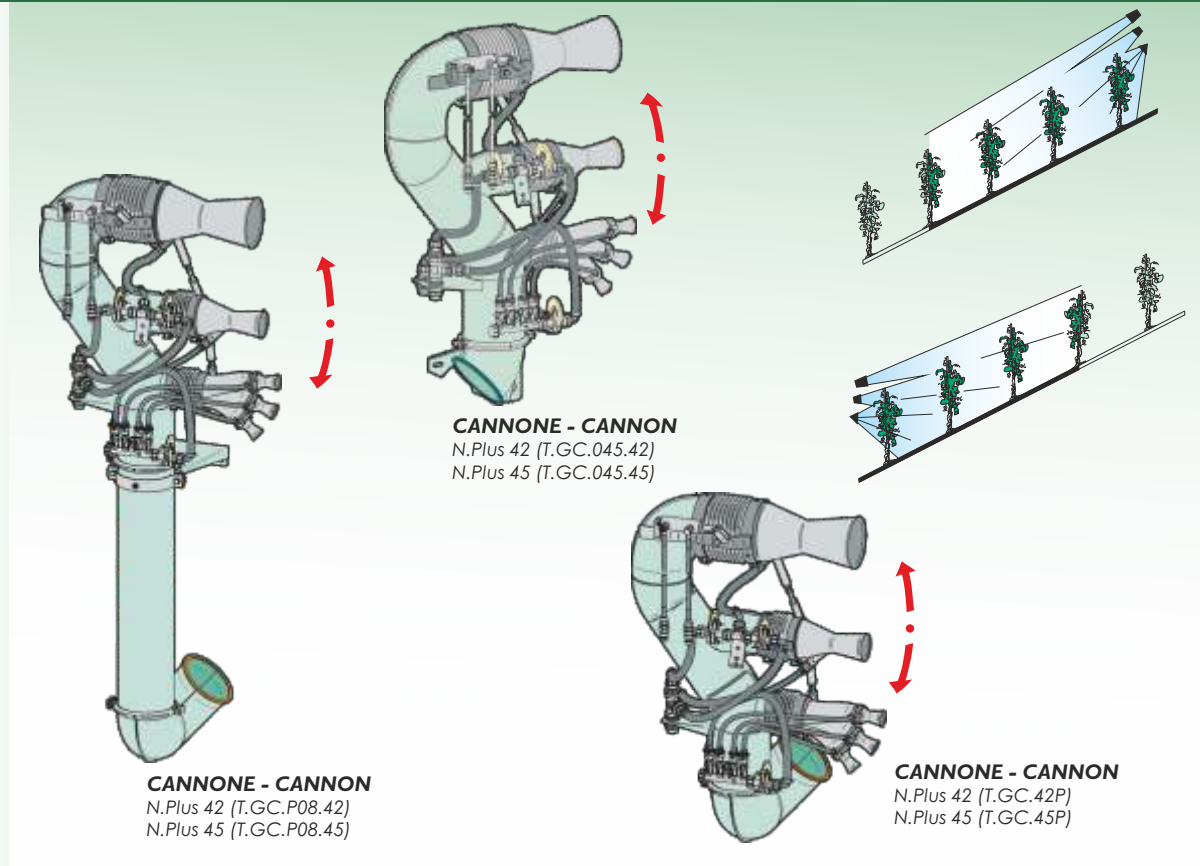

**CANNONE - CANNON**  
N.Plus 42 (T.GC.P08.42)  
N.Plus 45 (T.GC.P08.45)

**CANNONE - CANNON**  
N.Plus 42 (T.GC.045.42)  
N.Plus 45 (T.GC.045.45)

**CANNONE - CANNON**  
N.Plus 42 (T.GC.42P)  
N.Plus 45 (T.GC.45P)

# ACCESSORI - OPTIONAL DEVICES

## KIT PISTONI IDRAULICI HYDRAULIC-CYLINDER KIT

disponibile per:  
available for:  
T. 4+4  
T. 5+5  
T.OL

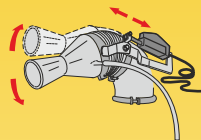
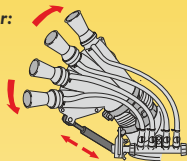

## KIT PISTONI ELETTRICI ELECTRO-CYLINDER KIT

(solo cannoni superiori)  
(only for upper cannons)

## GRUPPO 2 ELETTROVALVOLE SUPPLEMENTARI 2 ADDITIONAL ELECTROVALVES ASSEMBLY

N.Plus 45-50 (D.4E.P11)



## REGOLATORE ELETTRICO PRESSIONE ELECTRICAL PRESSURE REGULATION VALVE

N. Plus 42-45 (D.V.P01)

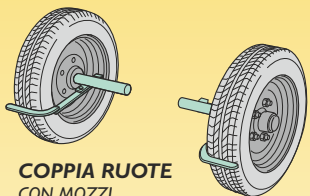

## COPPIA RUOTE CON MOZZI PAIR OF WHEELS WITH HUBS

N.Plus 42-45 (T.CPP.RT.01)

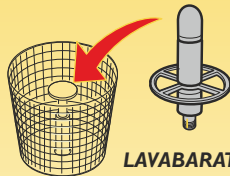

## LAVABARATTOLI CONTAINER WASHING DEVICE (KIT.LAV.BOX)



## KIT EASY FARM EASY FARM KIT

N.Plus 45-50 (K.EASYFARM.01)

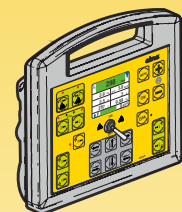

## E.P.A. 2.0

Erogazione Proporzionale Avanzamento  
Delivery Proportional to the Advance  
N.Plus 42-45 (EPA.P11)

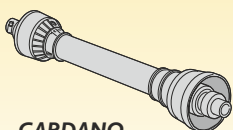

## CARDANO CARDAN SHAFT

N. Plus 42 (KHP.040.090)  
N. Plus 45 (KHP.050.090)

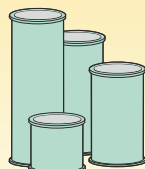

## PROLUNGHE - EXTENSIONS

N.Plus 42-45 D-175mm  
200mm (X02.186.000) - 400mm (X02.187.000)  
600mm (X02.188.000) - 800mm (X02.189.000)



## COLLARE - COLLAR

D-175mm (X05.616.000)

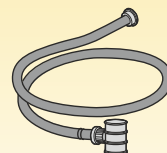

## TUBAZIONE RIEMPIMENTO FILLING PIPE

N. Plus 42-45 (TUBAZ.RIEMP)

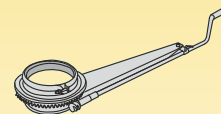

## GIREVOLE MANUALE MANUAL SWIVELLING DEVICE

N.Plus 42-45 (T.GIR.M.175P)

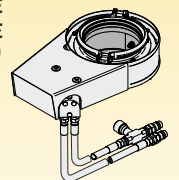





## GIREVOLE IDRAULICO HYDRAULIC SWIVELLING DEVICE

N.Plus 42-45 (T.GIR.I.175P)

Alcuni accessori sono forniti di serie in certi paesi - Some options are standard supplied in some countries



# INFORMAZIONI TECNICHE TECHNICAL INFORMATION

		New Plus 42	New Plus 45
	TRATTRICE	potenza richiesta 18 kW - 25 CV	potenza richiesta 33 kW - 45 CV
	TRACTOR	required power 18 kW - 25 HP	required power 33 kW - 45 HP
	ATOMIZZATORE	potenza assorbita 13 kW - 18 CV	potenza assorbita 17 kW - 23 CV
	SPRAYER	absorbed power 13 kW - 18 HP	absorbed power 17 kW - 23 HP
	VENTOLA	radiale in acciaio chiusa D.450 mm 4000 giri/min. portata aria: 4000 m <sup>3</sup> /h velocità aria: 228 m/s	radiale in acciaio chiusa 450 mm 4500 giri/min. portata aria: 5400 m <sup>3</sup> /h velocità aria: 188 m/s
	FAN	450 mm dia. steel closed radial fan - 4000 rpm air delivery 4000 m <sup>3</sup> /h - air speed: 228 m/s	450 mm dia. steel closed radial fan - 4500 rpm air delivery 5400 m <sup>3</sup> /h - air speed: 188 m/s
	POMPA	centrifuga di alimentazione e agitazione CIMA CD 32 - 4000 giri/min. portata 120 l/min. - pressione massima 4,5 kg/cm <sup>2</sup>	centrifuga di alimentazione e agitazione CIMA CD 32 - 4250 giri/min. portata 140 l/min. - pressione massima 4,5 kg/cm <sup>2</sup>
	PUMP	centrifugal spray and agitation CIMA CD 32 pump - 4000 rpm - 120 l/min. delivery - 4,5 kg/cm <sup>2</sup> max pressure	centrifuge CIMA CD 32 - 4250 t/mn débit 140 l/mn - pression max 4,5 kg/cm <sup>2</sup>

Valori suscettibili di variazioni in funzione del dispositivo di distribuzione utilizzato  
Values can vary according to the used distribution sprayhead

## DIMENSIONI E PESO - DIMENSIONS AND WEIGHT

		New Plus 42-45		New Plus Gold 42-45	
		I. 300	I. 400	I. 300	I. 400
	LUNGHEZZA	144-162 cm	144-162 cm	144-162 cm	144-162 cm
	LENGTH				
	LARGHEZZA	96 cm	112 cm	96 cm	112 cm
	WIDTH				
	ALTEZZA	119 cm	122 cm	127 cm	130 cm
	HEIGHT				
	PESO	42: 208 kg 45: 210 kg	42: 211 kg 45: 213 kg	42: 216 kg 45: 218 kg	42: 219 kg 45: 221 kg
	WEIGHT				

Il peso indicato è calcolato a vuoto SENZA il dispositivo di distribuzione e SENZA gli accessori eventualmente installati.  
I valori sono riportati a titolo indicativo e possono variare secondo la configurazione della macchina.  
Weight empty without distribution device and installed accessories.  
The value are indicative only, and may vary depending on the configuration of the machine.

Nei paesi dell'Unione Europea le nostre attrezzature sono conformi alla Direttiva Europea "Macchine"; negli altri paesi sono conformi alle norme di sicurezza in vigore in quei paesi.



Within the European Union countries our equipments are in accordance with the "Machines" European Directive; in other countries they comply with safety regulations in force in those specific countries.

**cima**<sup>®</sup>



RIVENDITORE AUTORIZZATO - DEALER

Loc. Molino Quaroni n.7, Montù Beccaria - PV - (ITALY)  
Tel. +39.0385.246636 - www.cima.it



10/2022