

cima[®]

ATOMIZZATORI-IMPOLVERATORI

New Plus 42-45



ATOMIZADOR BAJO VOLUMEN NEUMÁTICO

Atomizzatori - Atomizadores



☆ Ampia scelta di testate di distribuzione, tutte dotate del nuovo sistema anti-gocciolamento (brev. N°1745689) e di dispositivi di diffusione (mani e/o cannoni) di diverse dimensioni, **adattabili in altezza, orientabili ed intercambiabili** per garantire, su tutte le tipologie di colture, un'eccellente copertura e penetrazione nella vegetazione.



☆ Amplia gama de cabezales de distribución, todos equipados con el nuevo sistema antigoteo (pat. N.º 1745689) y dispositivos de difusión (manos y/o cañones) de diferentes dimensiones, **orientables e intercambiables**, para garantizar una excelente cobertura y penetración en cualquier tipo de cultivo.

☆ **Regolatori a disco rotante** con 15 fori calibrati (brev. N°23238), sostituiscono il sistema a pastiglie. **Erogazione da 70 a 3400 litri/ora**

☆ **Reguladores de disco giratorio** con 15 orificios calibrados (pat. N.º 23238) sustituyen el sistema de pastillas. **Distribución de 70 a 3400 l/h**



☆ Serbatoio in polietilene rotazionale, apertura di riempimento di grandi dimensioni (ø360) con coperchio a cerniera, indicatore di livello.

☆ Serbatoio lavamani integrato l.15.

☆ Serbatoio lavaimpianto integrato nel serbatoio principale (versioni GOLD).

☆ **Idromiscelatore integrato nel filtro a tazza.**

☆ **Doppia agitazione, idraulica e pneumatica.**

☆ **Trasmissione a cinghia poly-V** che assorbe le sollecitazioni. **Funzionamento per oltre 5000 ore.** Il tenditore automatico evita lo slittamento e quindi l'usura. La qualità della polverizzazione resta inalterata nel tempo.

☆ **Ruota libera di sicurezza per arresto improvviso.**

☆ **Transmisión con correa poly-V**, que absorbe los esfuerzos. **Funcionamiento por más de 5000 horas.** El tensor automático evita el deslizamiento y, en consecuencia, el desgaste. La calidad de la pulverización permanece inalterada en el tiempo.



☆ **Rueda libre de seguridad para paradas repentinas.**

Lavamani
Lavado de las manos

Lavaimpianto
Lavado de la instalación

Doppia agitazione
Doble agitación

Dalla pompa
Desde la bomba

☆ Tanque rotomoldeado de polietileno; apertura de llenado de grandes dimensiones (ø 360) con tapa engoznada e indicador de nivel.

☆ Tanque para el lavado de las manos integrado l.15.

☆ Tanque para el lavado de la instalación integrado en el tanque principal (versiones GOLD).

☆ **Hidromezcladora integrada en el filtro de taza.**

☆ **Doble agitación, hidráulica y neumática.**

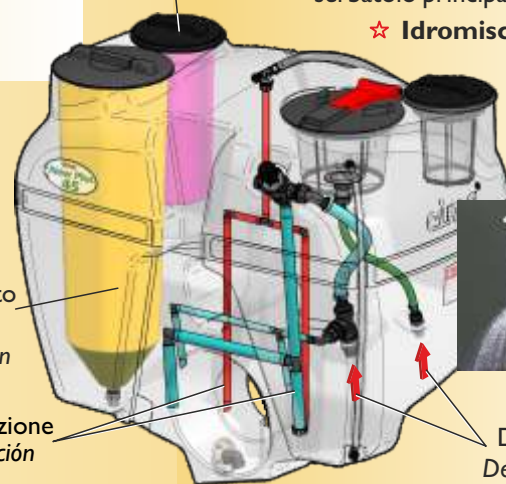

New Plus 42 - 45



- ★ Telaio in acciaio, verniciatura elettrostatica con polvere poliestere e predisposto per applicare coppia ruote.
- ★ Cerchio di protezione delle testate.
- ★ Ventola centrifuga chiusa ad alta pressione, in acciaio, con disinnesto; carter in polietilene rotazionale.
- ★ Controllo dal posto operatore dell'erogazione con due elettrovalvole.



- ★ Bastidor de acero preparado para la colocación de un par de ruedas; pintura electrostática con polvo poliéster.
- ★ Aro de protección de los cabezales.
- ★ Ventilador centrifugo cerrada de alta presión de acero, con desacoplamiento; cárter rotomoldeado de polietileno.
- ★ Control de la distribución desde el puesto del operador, con dos electroválvulas.



- ★ Regolatore di pressione manuale (a comando elettrico dal posto operatore a richiesta).
- ★ Manometro (ø100) ben visibile dal posto operatore.
- ★ Filtro di grande portata: 240 l/min.



- ★ Regulador de presión manual (mando eléctrico desde el puesto del operador opcional).



- ★ Manómetro (ø 100) bien visible desde el puesto del operador.
- ★ Filtro de gran caudal: 240 l/min.

- ★ **La pompa centrifuga** di fabbricazione C.I.M.A. (senza membrane e valvole) costruita in materiale anticorrosivo è **esente da manutenzione**. La cinghia di trasmissione 3V è dotata di tenditore automatico.



- ★ **La bomba centrifuga CIMA** (sin membranas ni válvulas), de material anticorrosivo, es **libre de mantenimiento**. La correa de transmisión 3V está dotada de tensor automático.



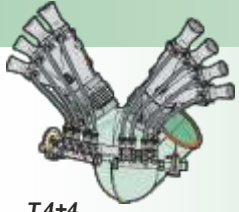
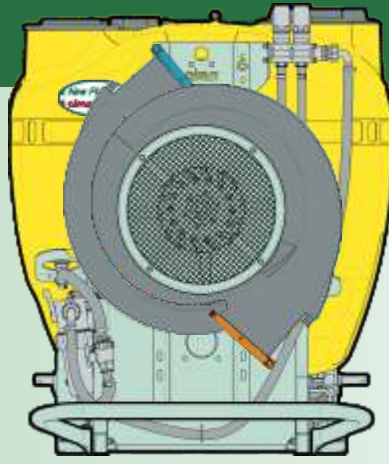

T.4+4
N.Plus 42 (T.4+4.42P)
N.Plus 45 (T.4+4.45P)

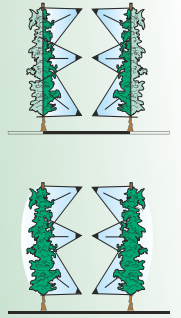
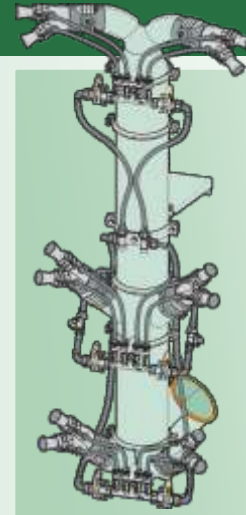
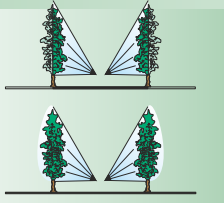

T.6M
N.Plus 42 (T.6M2D.42P)
N.Plus 45 (T.6M2D.45P)

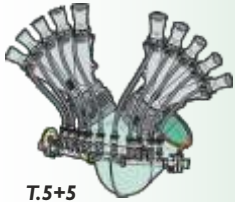

T.5+5
N.Plus 42 (T.5+5.42P)
N.Plus 45 (T.5+5.45P)

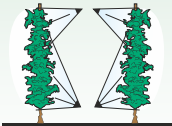
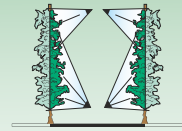
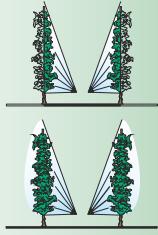

T.4M
N.Plus 42 (T.4M.42P)
N.Plus 45 (T.4M.45P)

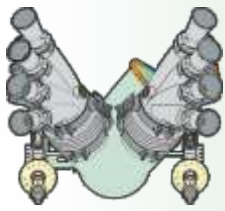
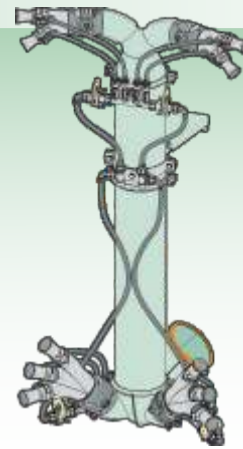

STRASBURGO - ESTRASBURGO
N.Plus 42 (T.ST4.42P)
N.Plus 45 (T.ST4.45P)

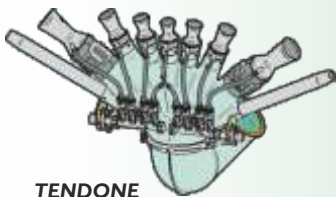
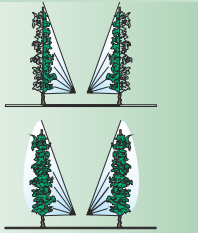

TENDONE
N.Plus 42 (T.TND.42P)
N.Plus 45 (T.TND.45P)

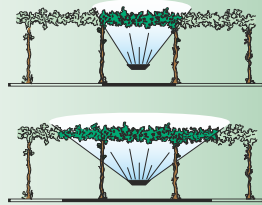

2 VENTAGLI - 2 ABANICOS
N.Plus 42-45 (T.2V3S.45P)

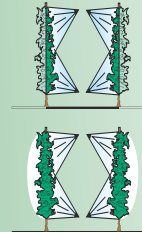
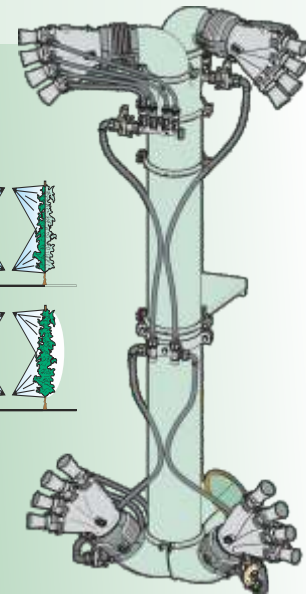
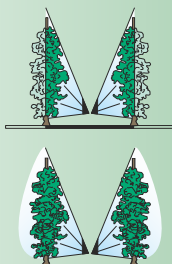

TC.2M2M
N.Plus 45 (TC.2M2M.45P)

TESTATE -

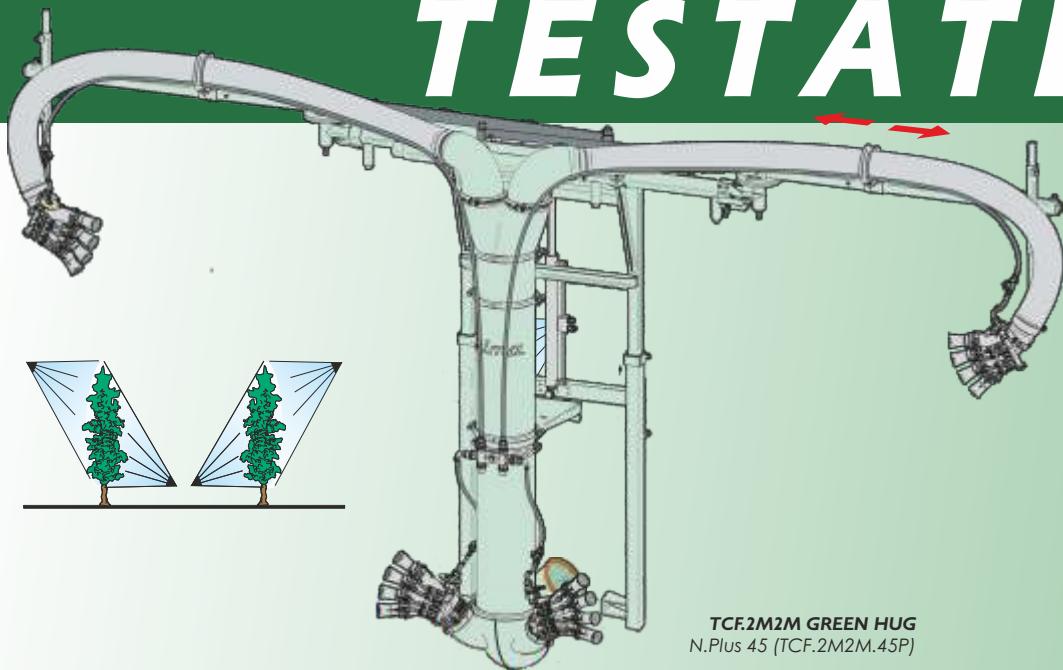

TCF.2M2M GREEN HUG
N.Plus 45 (TCF.2M2M.45P)

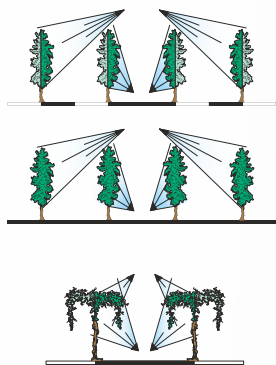

TC.2M2C
N.Plus 45 (TC.2M2C.45P)

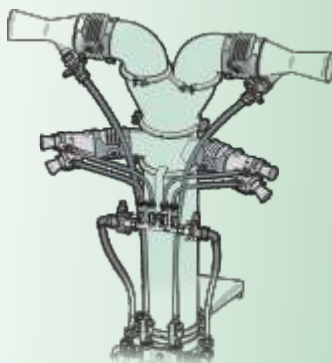
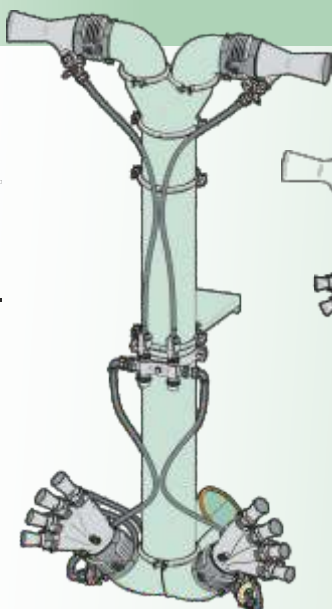

TC.4M2C
N.Plus 45 (TC.4M2C.45P)

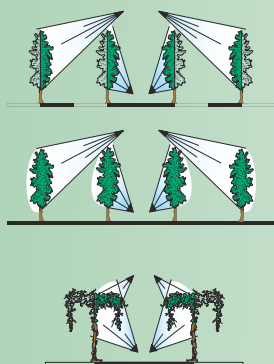
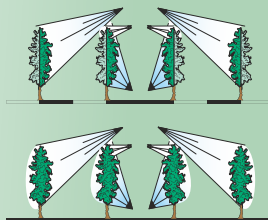

TCS.2M2C
N.Plus 45 (TCS.2M2C.45P)

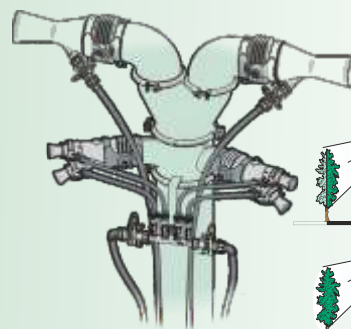
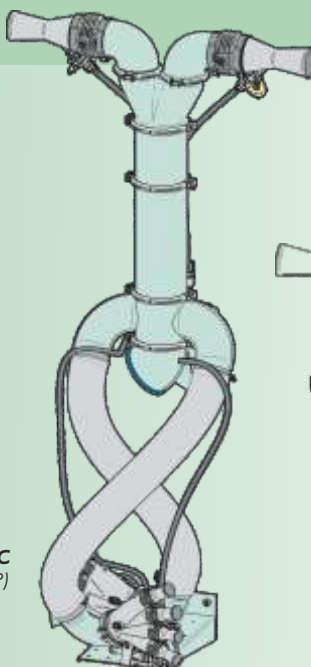

TCS.4M2C
N.Plus 45 (TCS.4M2C.45P)

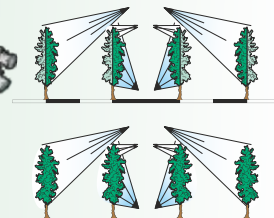

CABEZALES

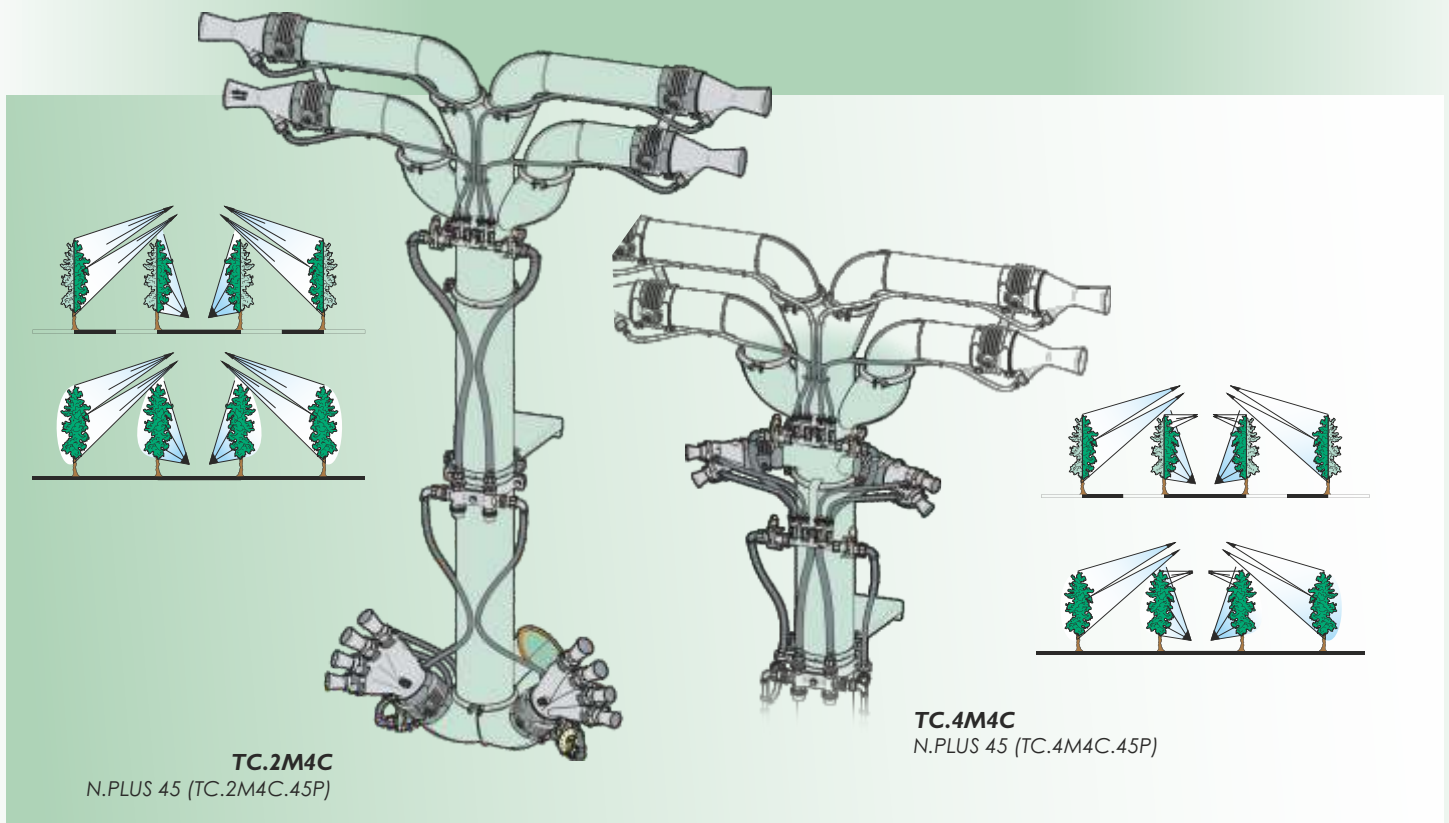

TC.2M4C
N.PLUS 45 (TC.2M4C.45P)

TC.4M4C
N.PLUS 45 (TC.4M4C.45P)

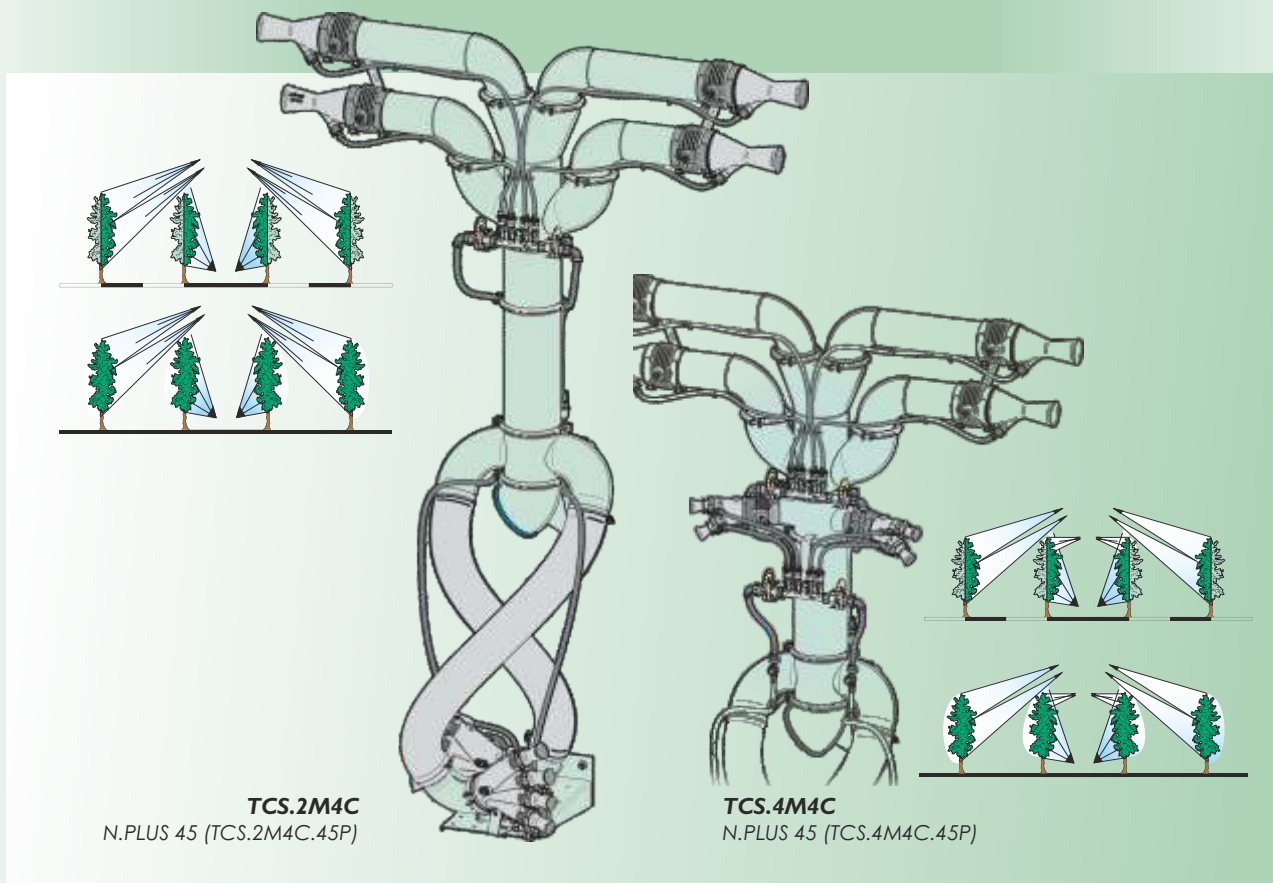

TCS.2M4C
N.PLUS 45 (TCS.2M4C.45P)

TCS.4M4C
N.PLUS 45 (TCS.4M4C.45P)

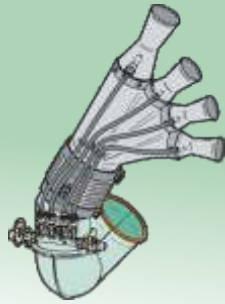

OLIVO
N.Plus 42 (T.OL.42P)
N.Plus 45 (T.OL.45P)

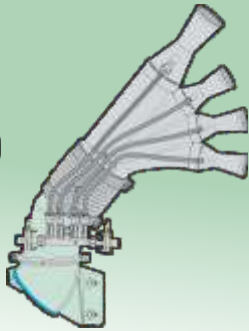

OLIVO
N.Plus 42 (T.OL.045.42)
N.Plus 45 (T.OL.045.45)

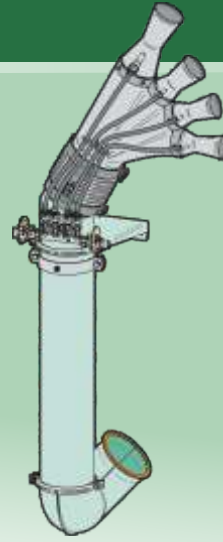
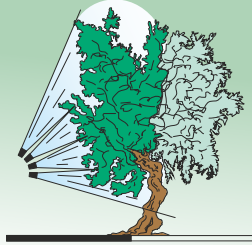

OLIVO
N.Plus 42 (T.OL.P08.42)
N.Plus 45 (T.OL.P08.45)

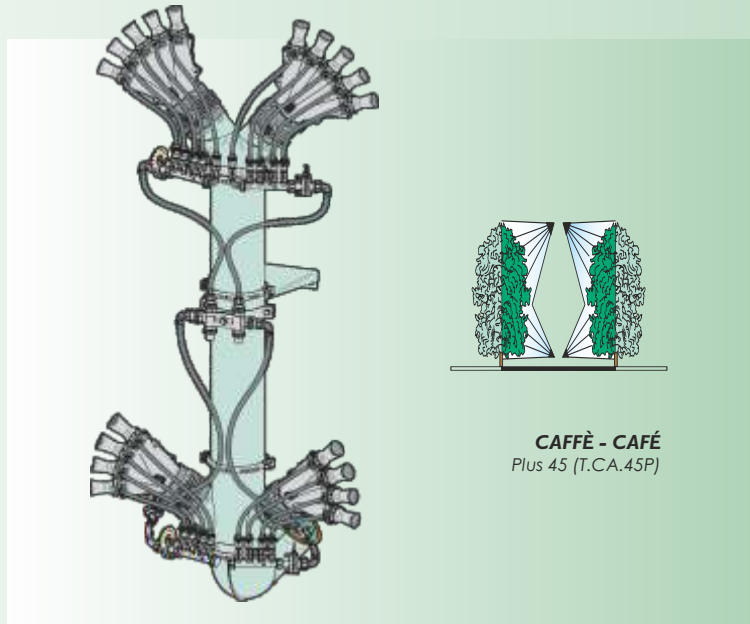
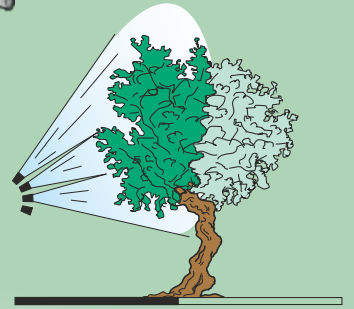

CAFFÈ - CAFÉ
Plus 45 (T.CA.45P)

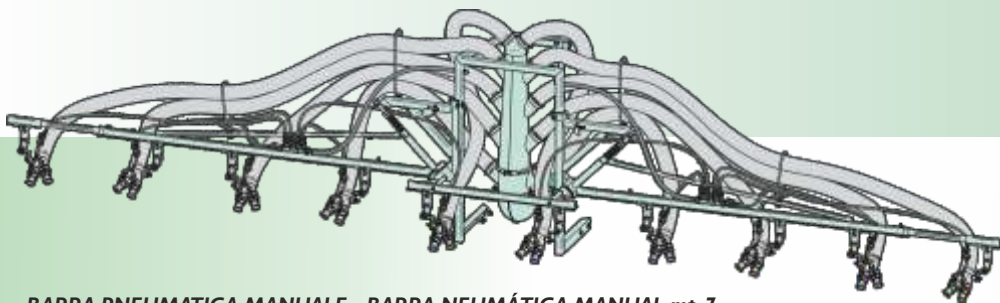

BARRA PNEUMATICA MANUALE - BARRA NEUMÁTICA MANUAL mt. 7
N.Plus 45 (BM10.2.66.45)

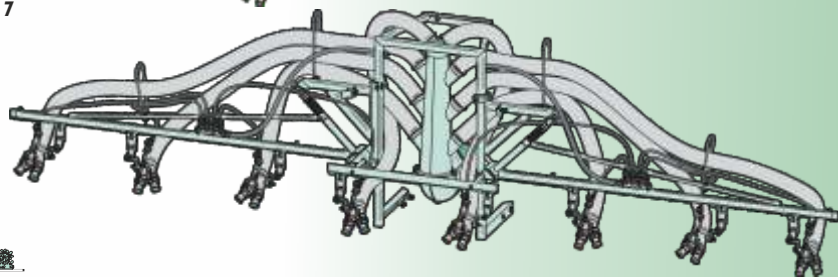

BARRA PNEUMATICA MANUALE - BARRA NEUMÁTICA MANUAL mt. 5
N.Plus 42 (BM08.2.66.42)
N.Plus 45 (BM08.2.66.45)

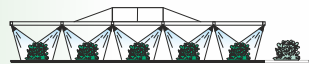

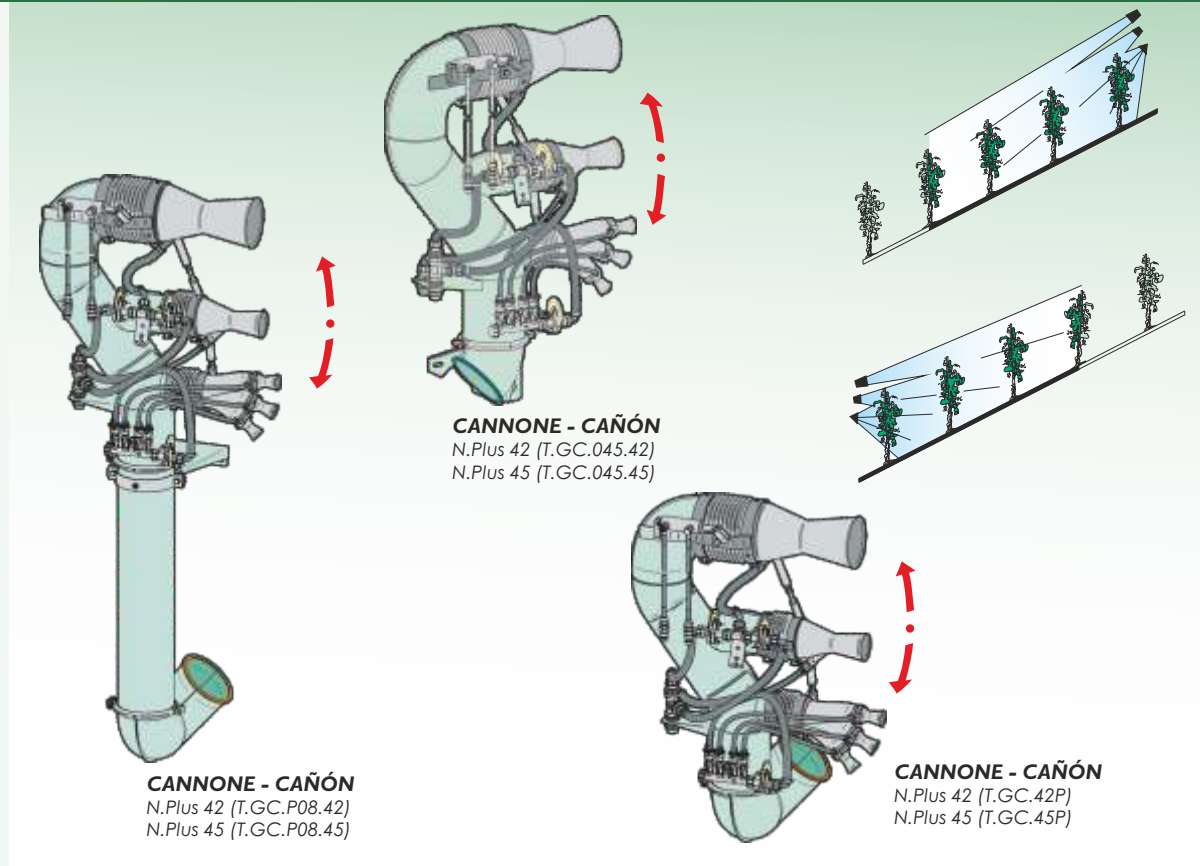

CANNONE - CAÑÓN
N.Plus 42 (T.GC.P08.42)
N.Plus 45 (T.GC.P08.45)

CANNONE - CAÑÓN
N.Plus 42 (T.GC.045.42)
N.Plus 45 (T.GC.045.45)

CANNONE - CAÑÓN
N.Plus 42 (T.GC.42P)
N.Plus 45 (T.GC.45P)

ACCESSORI - ACCESORIOS DISPONIBILES

KIT PISTONI IDRAULICI KIT DE PISTONES HIDRÁULICOS

disponibile per:
disponibile para:
T. 4+4
T. 5+5
T.OL

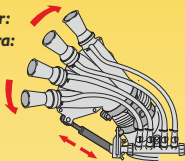

KIT PISTONI ELETTRICI (solo cannoni superiori)

KIT DE PISTONES ELÉCTRICOS (solo para cañones superiores)

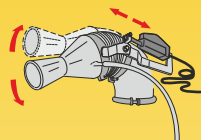

GRUPPO 2 ELETTROVALVOLE SUPPLEMENTARI GRUPO 2 ELECTROVÁLVULAS ADICIONALES

N.Plus 45-50 (D.4E.P11)



REGOLATORE ELETTRICO PRESSIONE REGULADOR ELÉCTRICO DE PRESIÓN

N. Plus 42-45 (D.V.P01)

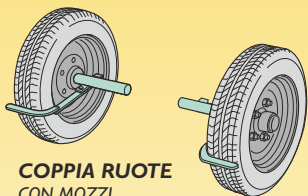

COPPIA RUOTE CON MOZZI PAR DE RUEDAS CON CUBOS

N.Plus 42-45 (T.CPP.RT.01)

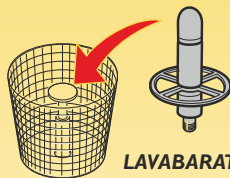

LAVABARATTOLI DISPOSITIVO DE LAVADO DE CONTENEDORES (KIT.LAV.BOX)



KIT EASY FARM KIT EASY FARM

N.Plus 45-50 (K.EASYFARM.01)

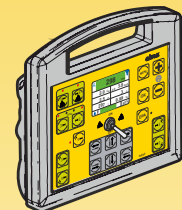

E.P.A. 2.0

Erogazione Proporzionale Avanzamento
Distribución Proporcional de Avance
N.Plus 42-45 (EPA.P11)

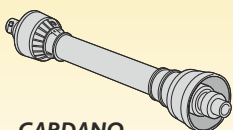

CARDANO CARDÁN

N. Plus 42 (KHP.040.090)
N. Plus 45 (KHP.050.090)

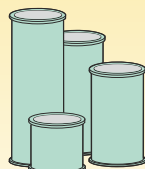

PROLUNGHE - ALARGADERAS

N.Plus 42-45 D-175mm
200mm (X02.186.000) - 400mm (X02.187.000)
600mm (X02.188.000) - 800mm (X02.189.000)



COLLARE - COLLARES

D-175mm (X05.616.000)

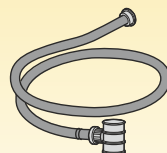

TUBAZIONE RIEMPIMENTO TUBO DE LLENADO

N. Plus 42-45 (TUBAZ.RIEMP)

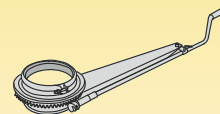

GIREVOLE MANUALE GIRATORIO MANUALE

N.Plus 42-45 (T.GIR.M.175P)

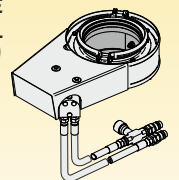





GIREVOLE IDRAULICO GIRATORIO HIDRÁULICO

N.Plus 42-45 (T.GIR.I.175P)

INFORMAZIONI TECNICHE

INFORMACIÓN TÉCNICA

		New Plus 42	New Plus 45
	TRATTRICE	potenza richiesta 18 kW - 25 CV	potenza richiesta 33 kW - 45 CV
	TRACTOR	potencia requerida 18 kW - 25 HP	potencia requerida 33 kW - 45 HP
	ATOMIZZATORE	potenza assorbita 13 kW - 18 CV	potenza assorbita 17 kW - 23 CV
	ATOMIZADOR	potencia absorbida 13 kW - 18 HP	potencia absorbida 17 kW - 23 HP
	VENTOLA	radiale in acciaio chiusa D.450 mm 4000 giri/min. portata aria: 4000 m ³ /h velocità aria: 228 m/s	radiale in acciaio chiusa 450 mm 4500 giri/min. portata aria: 5400 m ³ /h velocità aria: 188 m/s
	VENTILADOR	radial de acero cerrada D. 450 mm - 4000 rpm - caudal de aire: 4000 m ³ /h - velocidad del aire 228 m/s	radial de acero cerrada D. 450 mm - 4500 rpm - caudal de aire: 5400 m ³ /h - velocidad del aire 188 m/s
	POMPA	centrifuga di alimentazione e agitazione CIMA CD 32 - 4000 giri/min. portata 120 l/min. - pressione massima 4,5 kg/cm ²	centrifuga di alimentazione e agitazione CIMA CD 32 - 4250 giri/min. portata 140 l/min. - pressione massima 4,5 kg/cm ²
	BOMBA	centrífuga de alimentación y agitación CIMA CD 32 4000 rpm - caudal 120 l/min - presión máx. 4,5 kg/cm ²	centrífuga de alimentación y agitación CIMA CD 32 4250 rpm - caudal 140 l/min - presión máx. 4,5 kg/cm ²

Valori suscettibili di variazioni in funzione del dispositivo di distribuzione utilizzato
Valores susceptibles de variación en función del dispositivo de distribución utilizado

DIMENSIONI E PESO - DIMENSIONES Y PESOS

		New Plus 42-45		New Plus Gold 42-45	
		I. 300	I. 400	I. 300	I. 400
	LUNGHEZZA	144-162 cm	144-162 cm	144-162 cm	144-162 cm
	LONGITUD				
	LARGHEZZA	96 cm	112 cm	96 cm	112 cm
	ANCHO				
	ALTEZZA	119 cm	122 cm	127 cm	130 cm
	ALTURA				
	PESO	42: 208 kg	42: 211 kg	42: 216 kg	42: 219 kg
	PESO ESTÁNDAR	45: 210 kg	45: 213 kg	45: 218 kg	45: 221 kg

Il peso indicato è calcolato a vuoto SENZA il dispositivo di distribuzione e SENZA gli accessori eventualmente installati.
I valori sono riportati a titolo indicativo e possono variare secondo la configurazione della macchina.
El peso se indica para un atomizador vacío, SIN el cabezal y SIN de los accesorios que se pueden instalar
Los valores indicados son indicativos y pueden variar según la configuración de la máquina.

Nei paesi dell'Unione Europea le nostre attrezzature sono conformi alla Direttiva Europea "Macchine"; negli altri paesi sono conformi alle norme di sicurezza in vigore in quei paesi.



En los países de la Unión Europea, nuestros productos responden a la Directiva Europea "Máquinas"; en los demás países, responden a las normas de seguridad vigentes en los mismos.

cima[®]



RIVENDITORE AUTORIZZATO
REVENDEDOR AUTORIZADO

Loc. Molino Quaroni n.7, Montù Beccaria - PV - (ITALY)
Tel. +39.0385.246636 - www.cima.it



10/2022