



**cima**<sup>®</sup>

ATOMIZZATORI-IMPOLVERATORI



**Blitz 55**

ATOMIZZATORI PNEUMATICI A BASSO VOLUME  
PNEUMATIQUES TRAINÉS

# Atomizzatori - Pneumatiques



☆ Ampia scelta di testate di distribuzione, tutte dotate del nuovo sistema anti-sgocciamento (brev. N°1745689) e di dispositivi di diffusione (mani e/o cannoni) di diverse dimensioni, **orientabili ed intercambiabili**, per garantire, su tutte le tipologie di colture, un'eccellente copertura e penetrazione nella vegetazione.



☆ Large choix d'équipements de pulvérisation, tous équipés du nouveau système antigoutte (brevet No.1745689) et des dispositifs de diffusion (mains et/ou canons) de dimensions différentes, **orientables et interchangeable**, pour garantir, à chaque type de culture, une meilleure pénétration et une couverture d'excellente qualité de la végétation.



☆ **Regolatori a disco rotante** con 15 fori calibrati (brev. N°23238), sostituiscono il sistema a pastiglie. **Erogazione da 100 a 5000 litri/ora**



☆ **Régulateurs à disques tournants** avec 15 trous calibrés (brevet No.23238) remplacent le système à pastilles. **Débit: de 100 à 5000 lh.**

☆ **Timone** : regolabile in lunghezza ed altezza

☆ **Attelage** avec anneau ou à chape timon réglable en longueur et en hauteur.

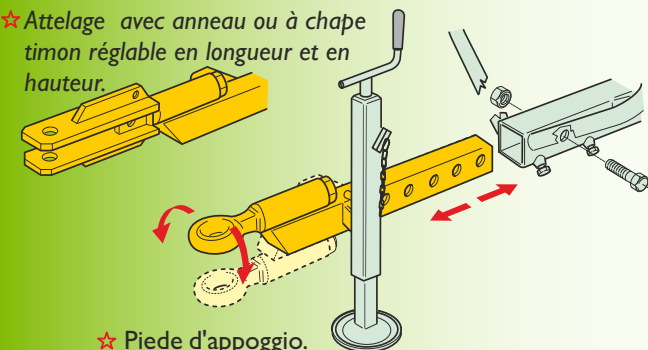

☆ Piede d'appoggio.  
☆ Béquille.

☆ **Mozzi delle ruote a carreggiata** ed altezza regolabile.

☆ **Moyeux des roues** : réglables en largeur et en hauteur.

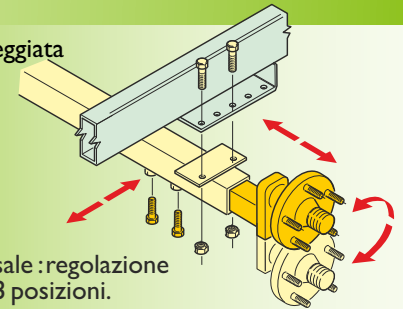

☆ **Assale** : regolazione su 3 posizioni.

☆ **Essieu** : réglage sur 3 positions.



# Blitz 55

- ☆ Serbatoio in polietilene rotazionale, apertura di riempimento di grandi dimensioni (Ø460) con coperchio a cerniera, indicatori di livello. Serbatoio lavamani l.30.
- ☆ Telaio in acciaio, verniciatura elettrostatica con polvere poliestere.
- ☆ Ventola centrifuga chiusa ad alta pressione, in acciaio, con disinnesto; carter in polietilene rotazionale.

- ☆ **Idromiscelatore integrato nel filtro a tazza.**
- ☆ **Doppia agitazione, idraulica e pneumatica.**
- ☆ Controllo dal posto operatore dell'erogazione con due elettrovalvole.
- ☆ Il serbatoio lavaimpianto (a richiesta), se mantenuto pieno, conferisce un'ottima stabilità anche a macchina vuota, essendo collocato sotto al serbatoio principale.



☆ Réservoir en polyéthylène rotomoulé. Large ouverture (Ø 460) avec couvercle à charnière, jauges graduées. Réservoir lave-mains 30 litres.

☆ Châssis articulé en acier avec peinture polyester électrostatique.

☆ **Tamis mélangeur intégré.**

☆ **Double agitation, hydro-pneumatique.**

☆ Turbine centrifuge fermée haute pression, en acier, débrayable dans volute en polyéthylène rotomoulée.

☆ Contrôle du débit à télécommande électrique depuis le poste de conduite.

☆ La cuve de rinçage (en option) si pleine, placée au-dessous du réservoir de l'appareil, donne une excellente stabilité même à réservoir vide.



☆

☆

☆ **Trasmissione a cinghia poly-V** qui absorbe toutes tensions. **Plus de 5000 heures de fonctionnement.** Le tendeur automatique évite le glissement et l'usure. La qualité de la pulvérisation reste inaltérée longtemps.

☆ **Roue libre de sécurité en cas d'arrêt soudain de la PdF** (en option).

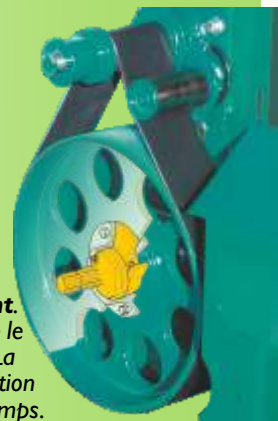

- ☆ Regolatore di pressione manuale (a comando elettrico dal posto operatore a richiesta).
- ☆ Manometro (Ø100) ben visibile dal posto operatore.
- ☆ Filtro di grande portata : 240 l/min.

☆ Régulateur de pression manuel (en option à commande électrique depuis le poste de conduite).

☆ Manomètre (Ø100), bien visible depuis le poste de conduite.

☆ Filtre à grand débit: 240 lmn.



☆ **La pompa centrifuga** di fabbricazione C.I.M.A. (senza membrane e valvole) costruita in materiale anticorrosivo è **esente da manutenzione.** La cinghia di trasmissione 3V è dotata di tenditore automatico.



☆ **La pompe centrifuge** fabrication C.I.M.A. (sans membranes et clapets) produite en matériel anti-corrosion **est fiable et sans entretien.** Sa courroie de transmission 3V est équipée d'un tendeur automatique.



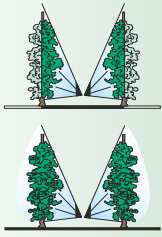

**2 VENTAGLI (3-8 settori)**  
**2 ÉVENTAILS (3-8 secteurs)**  
 Blitz 55 (T.2V3L.55T)  
 (T.2V8.55T)  
 (T.2V4.55T)

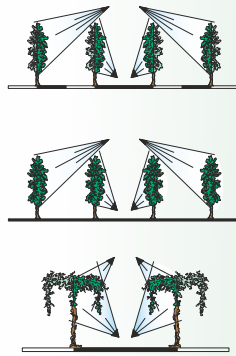
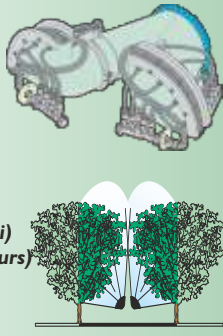

**TC.2M2C**  
 Blitz 55 (TC.2M2C.55T)

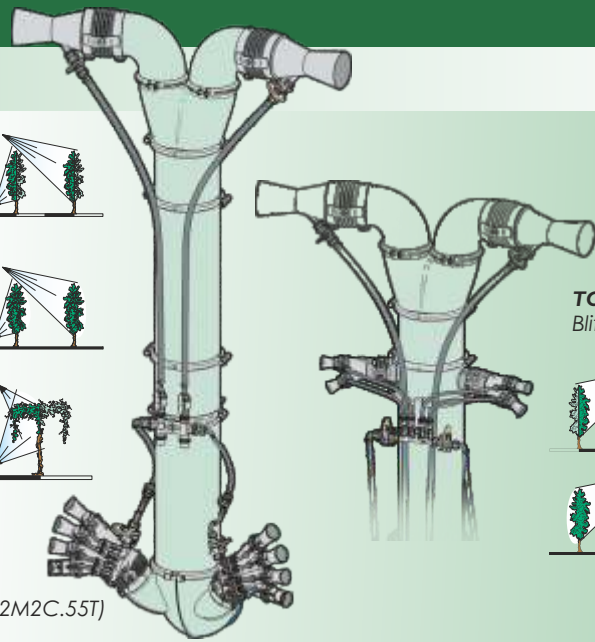

**TC.4M2C**  
 Blitz 55 (TC.4M2C.55T)

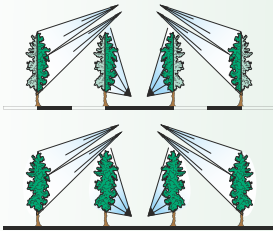
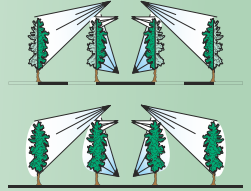

**TC.4M4C**  
 Blitz 55 (TC.4M4C.55T)

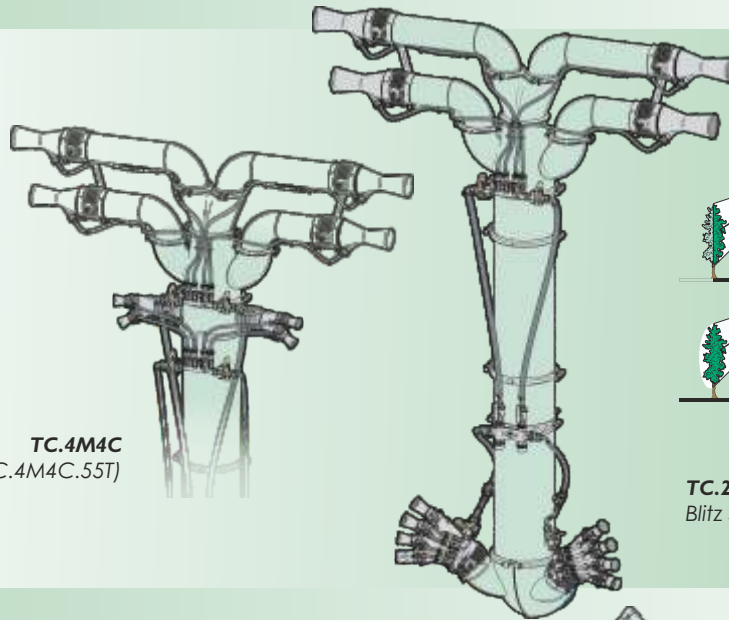

**TC.2M4C**  
 Blitz 55 (TC.2M4C.55T)

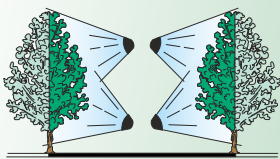
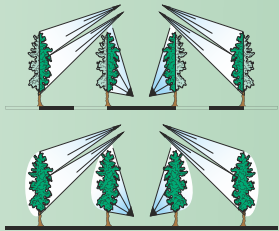

**4 VENTAGLI**  
**4 ÉVENTAILS**  
 Blitz 55 (T.4V.55T)

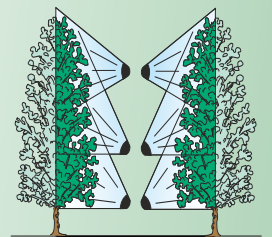
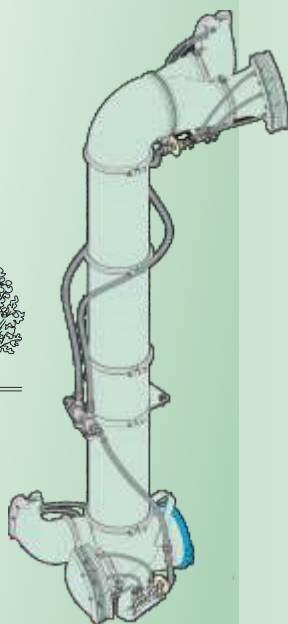

**6 VENTAGLI - 6 ÉVENTAILS**  
 Blitz 55 N-S (T.6V.55T)  
 Blitz 55 E (T.6V.55TE)

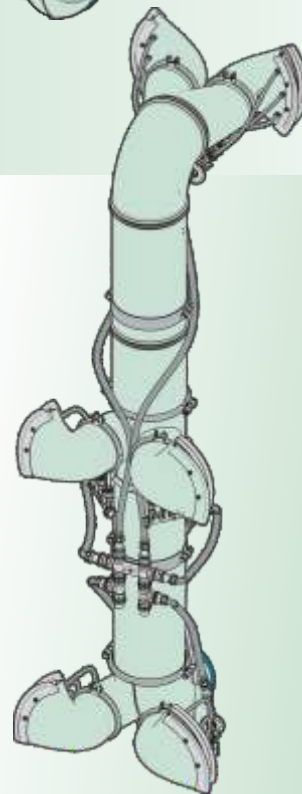

# TESTATE -

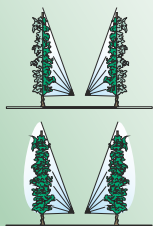

**T.5+5**  
Blitz 55 (T.5+5.55T)

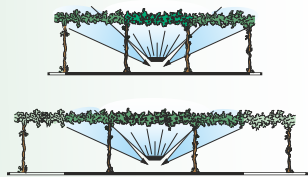
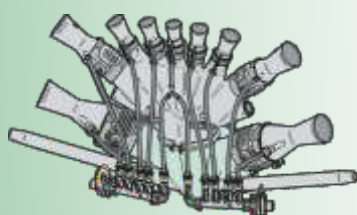
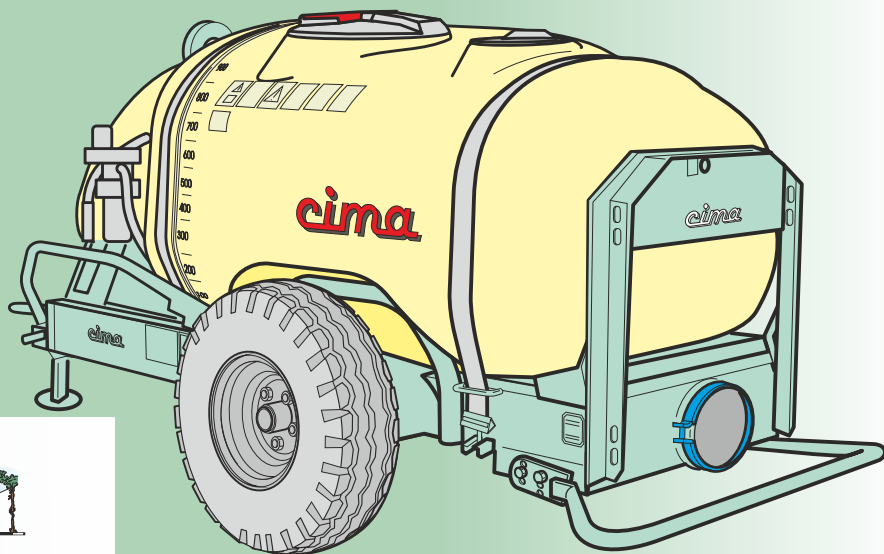

**TENDONE**  
Blitz 55 (T.TND.55T)

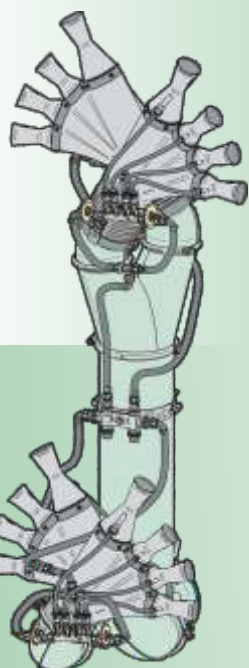

**T.4OL**  
Blitz 55 (T.4OL.3+3.55T)  
(T.4OL.4+3.55T)  
(T.4OL.4+4.55T)

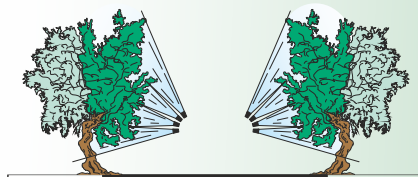

**OLIVO DOPPIA - DOUBLE OLIVIER**  
Blitz55 (T.2OL.55T)

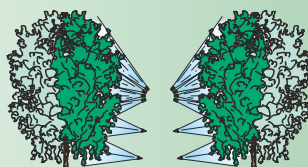
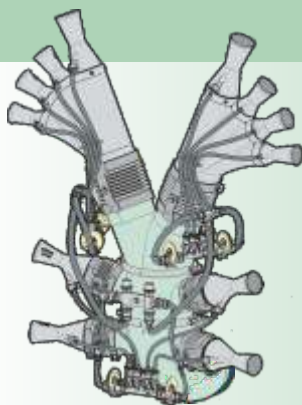
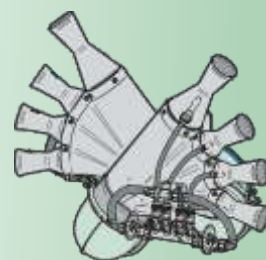

**T.4C2OL**  
Blitz 55 (T.4C2OL.55T)

# EQUIPEMENTS DE

MOVIMENTAZIONE IDRAULICA  
VERSION HYDRAULIQUE

PER ZONE VENTOSE  
POUR LES ZONES VENTEUSES

T.MULTI-VITIS 6M2C  
Blitz 55 (TCI.6M2C.55T)

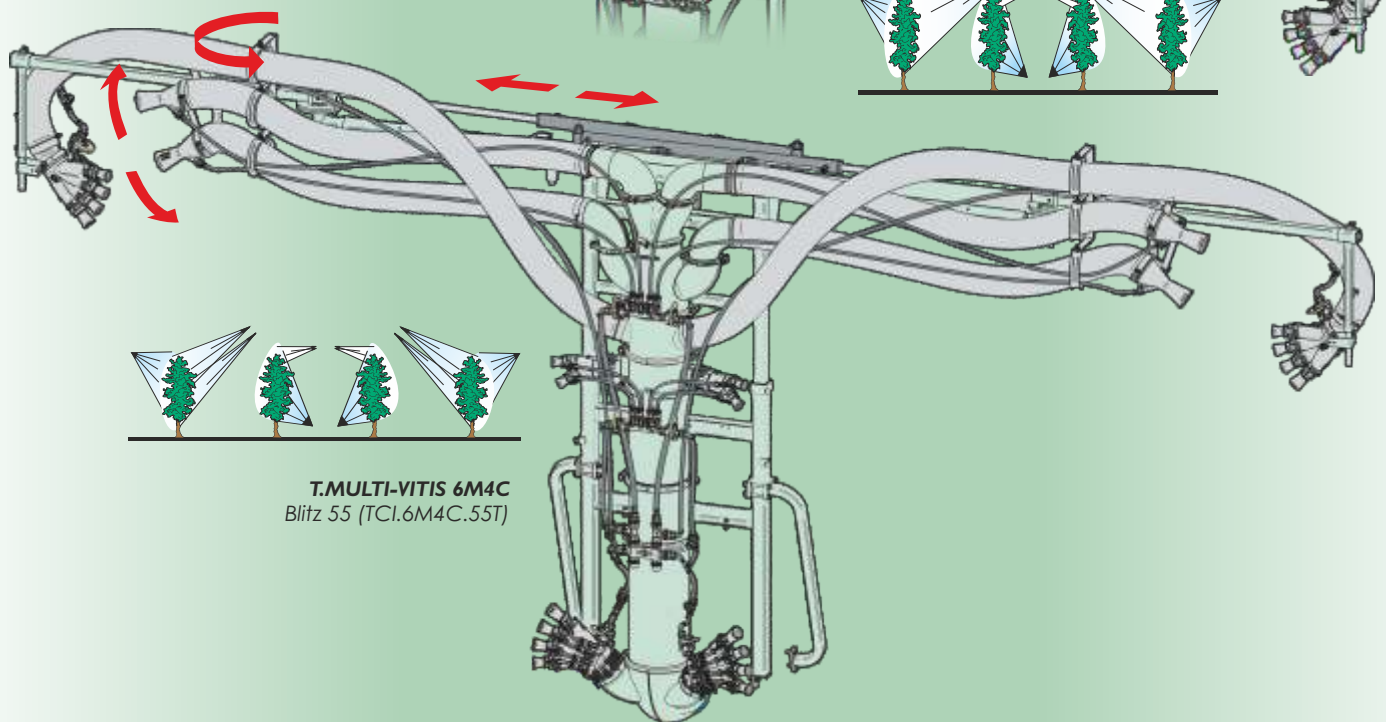
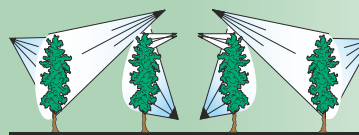

T.MULTI-VITIS 6M4C  
Blitz 55 (TCI.6M4C.55T)

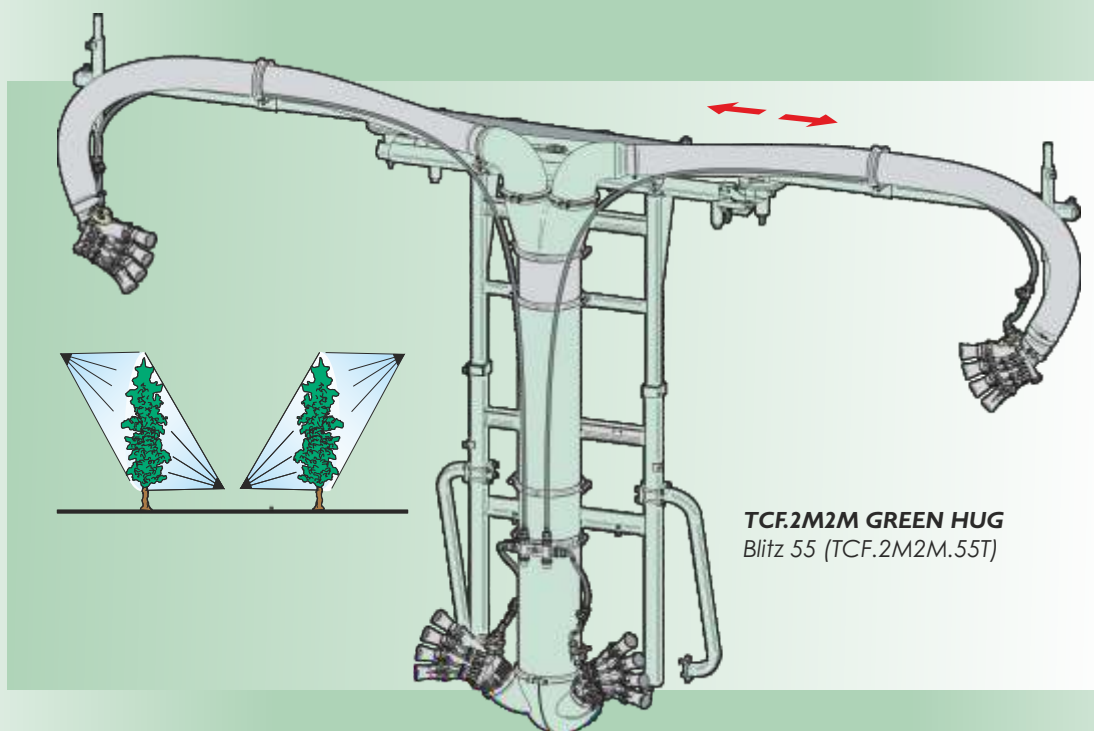

TCF.2M2M GREEN HUG  
Blitz 55 (TCF.2M2M.55T)

# DISTRIBUTION

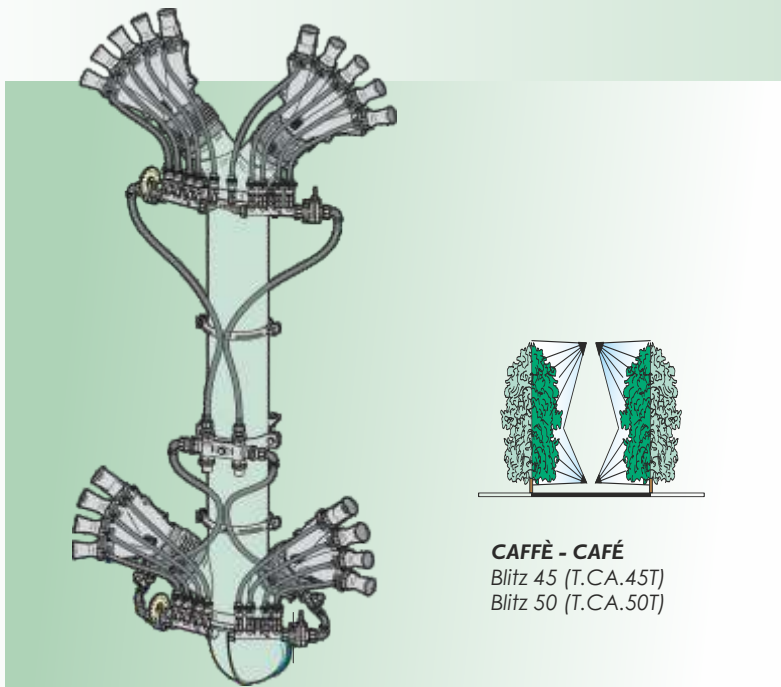
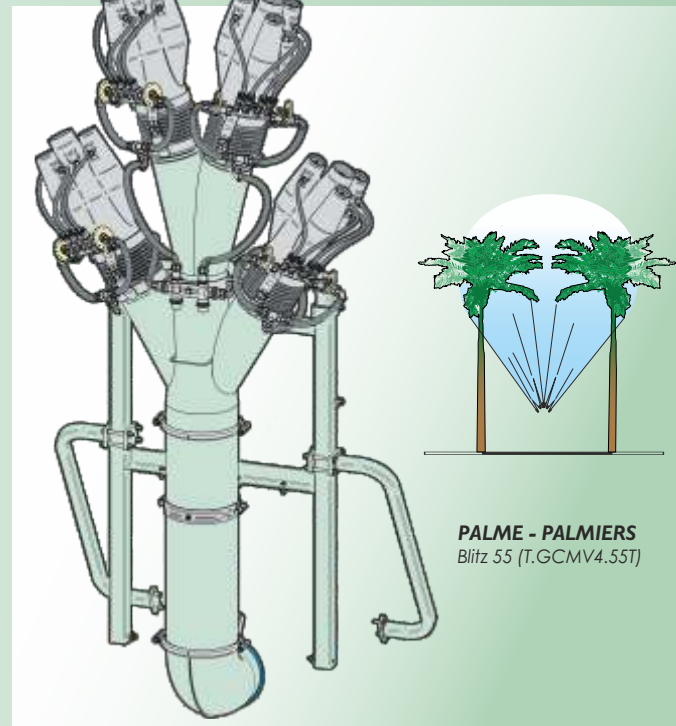
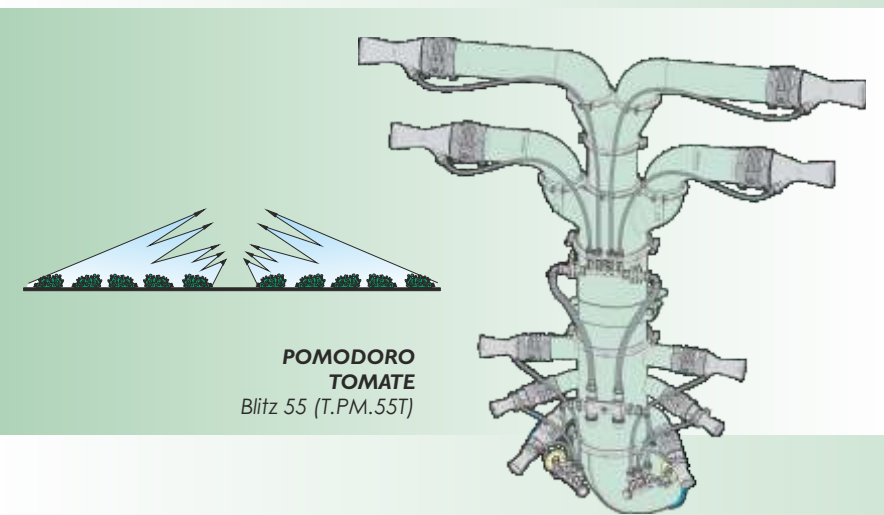
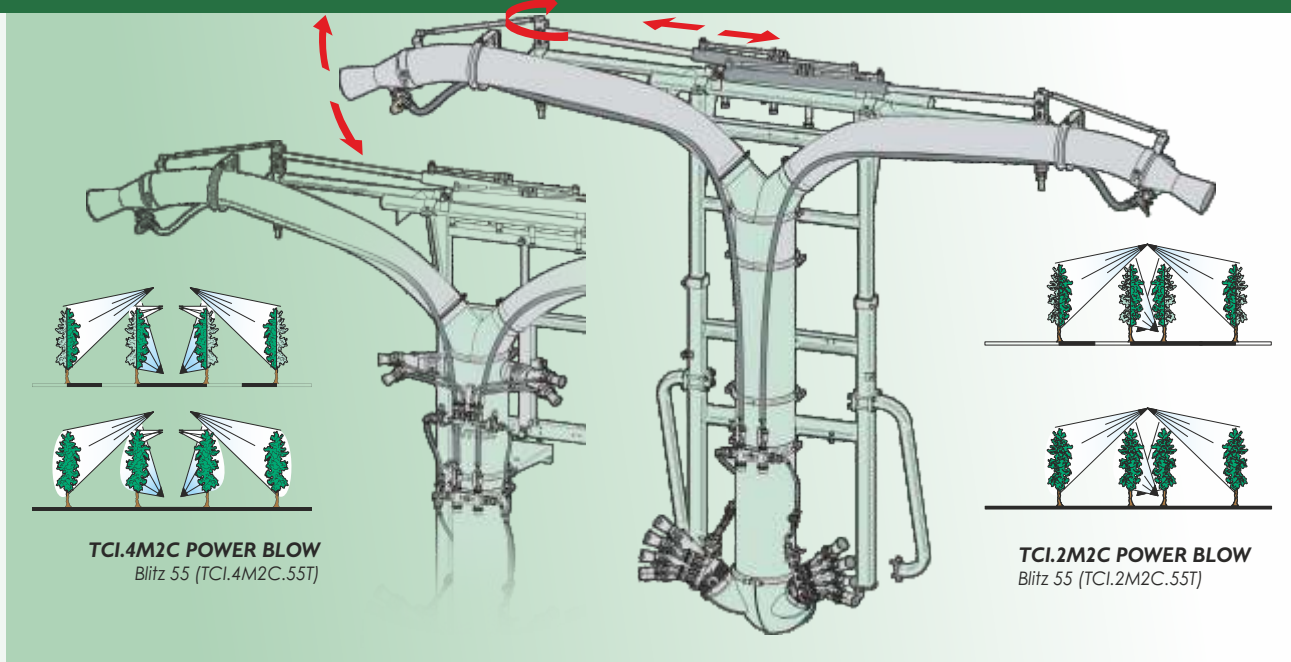

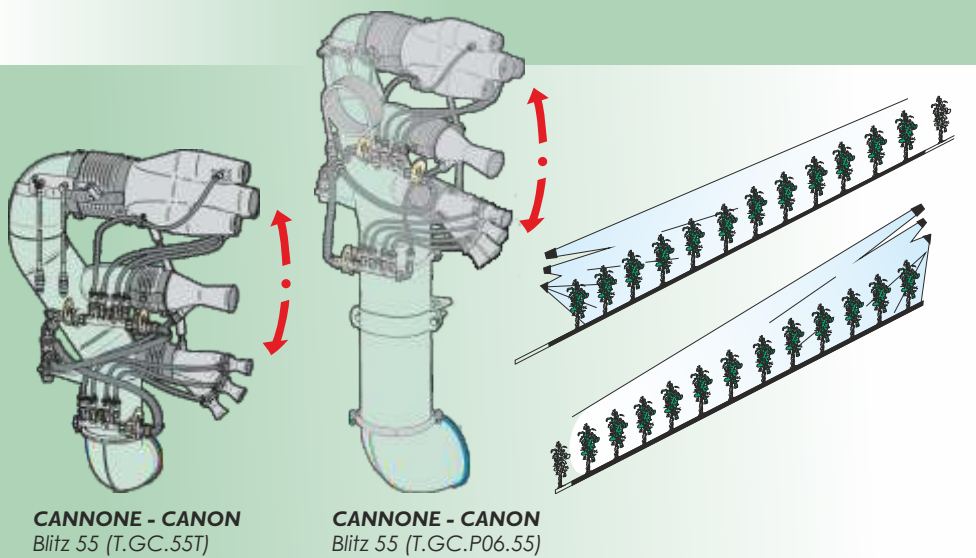

**CANNONE - CANON**  
Blitz 55 (T.GC.55T)

**CANNONE - CANON**  
Blitz 55 (T.GC.P06.55)

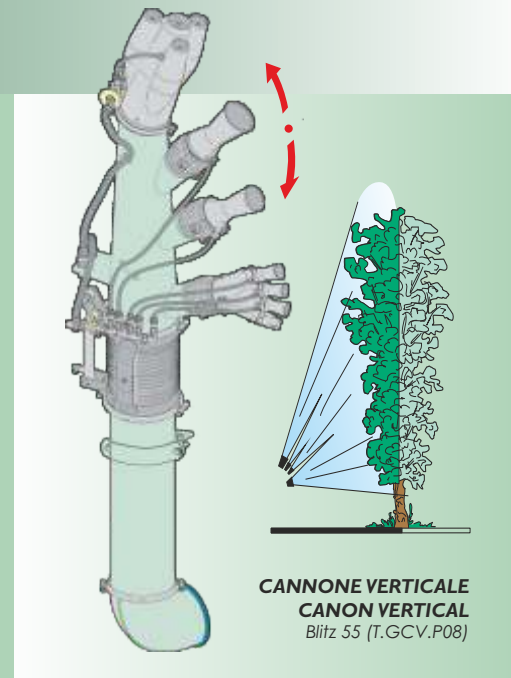

**CANNONE VERTICALE**  
**CANON VERTICAL**  
Blitz 55 (T.GCV.P08)

## ACCESSORI - ACCESSOIRES

### KIT CILINDRI IDRAULICI KIT VERRINS HYDRAULIQUES

disponibile per:  
disponible pour:  
T.5+5  
T.OL  
T.2C2OL  
T.4C2OL

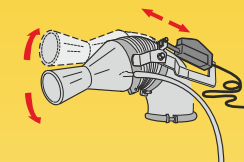
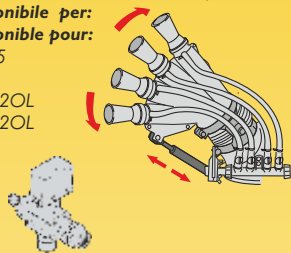

### KIT PISTONI ELETTRICI

(solo cannoni superiori)

### KIT VERRINS ÉLECTRIQUES

(seulement pour les canons supérieurs)

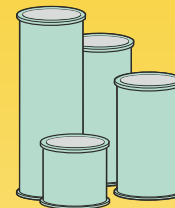

### PROLUNGHE - RALLONGES

Blitz 55 D-250mm  
200mm (X21.100.020) - 400mm (X21.100.040)  
600mm (X21.100.060) - 800mm (X21.100.080)



### COLLARE - COLLIER

D-250mm (X05.813.000)

### REGOLATORE ELETTRICO PRESSIONE VANNE RÉGLAGE ÉLECTRIQUE DE LA PRESSION

Blitz 55 (D.V.T01)

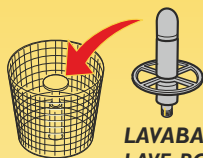

### LAVABARATTOLI LAVE-BOÎTES

Blitz 55 (KIT.LAV.BOX)

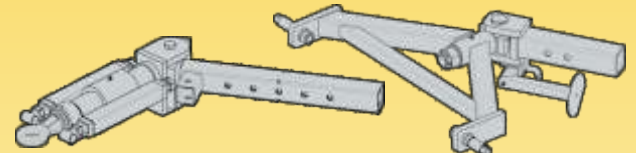

### TIMONE STERZANTE ATTELAGE ARTICULÉ

Blitz 55 lt. 1000 (DIF.TIM.STRZ.06) (DIF.TIM.STRZ.02)  
lt. 1500-2000 (DIF.TIM.STRZ.07) (TIM.STRZ.12)

### GRUPPO 2 ELETTROVALVOLE SUPPLEMENTARI GROUPE 2 ELECTROSOUPEAPE ADDITIONNEL

Blitz 55 (D.4E.T11)

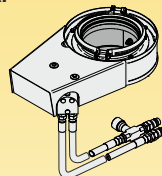

### GIREVOLE IDRAULICO PIVOTANT HYDRAULIQUE

Blitz 55 (T.GIR.I.250T)

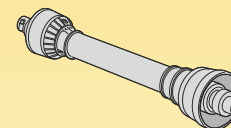

### CARDANO CARDAN

Blitz 55 (KHP.060.110)

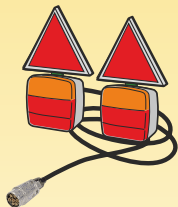

### KIT LUCI POSTERIORI KIT FEUX ARRIÈRES

Blitz 45-50 (KIT.LP.10.03)

### CARDANO OMOCINETICO CARDAN HOMOCINÉTIQUE

Blitz 55 (KHP.060.130G)

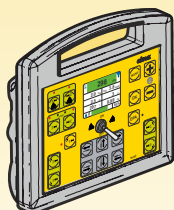
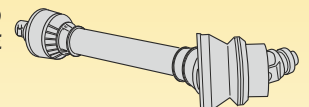

### E.P.A.

Erogazione Proporzionale Avanzamento  
Débit Proportionnel à l'Avancement  
Blitz 55 (EPA.T11)

### SENSORI ULTRASUONI CAPTEURS À ULTRASONS

Blitz 55 (D.SU2.EPA.T02)



### KIT EASY FARM KIT EASY FARM

Blitz 55 (K.EASYFARM.01)

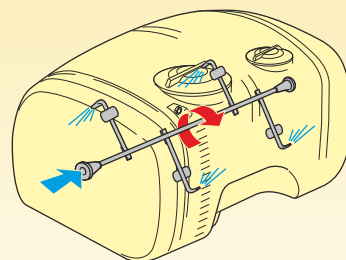

### IDROMISCELATORE ROTANTE A PALE AGITATEUR ROTATIF HYDRAULIQUE À VOILETS

Blitz 55 lt.1000 - 1500 - 2000

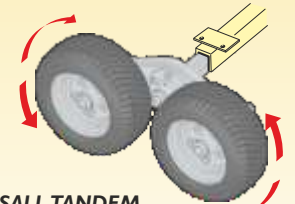

### ASSALI TANDEM ASSIEU À BALANCIER TANDEM



Blitz 55 lt.1000 (DIFF.RT.T.03)  
lt.1500 (DIFF.RT.T.04)  
lt.2000 (DIFF.RT.T.05)

Alcuni accessori sono forniti di serie in certi paesi - Certains accessoires sont fournis de série dans certains pays





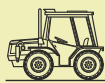

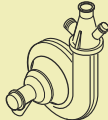
# INFORMAZIONI TECNICHE

## CARACTERISTIQUES TECHNIQUES

		<b>Blitz 55 N</b>	<b>Blitz 55 S</b>	<b>Blitz 55 E</b>
	TRATTRICE	potenza richiesta 52 kW - 70 CV	potenza richiesta 58 kW - 80 CV	potenza richiesta 66 kW - 90 CV
	TRACTEUR	puissance demandée 52 kW - 70 CV	puissance demandée 58 kW - 80 HP	puissance demandée 66 kW - 90 HP
	ATOMIZZATORE	potenza assorbita 26 kW - 36CV	potenza assorbita 34 kW - 47 CV	potenza assorbita 41 kW - 55 CV
	PNEUMATIQUE	puissance absorbée 26 kW - 36 CV	puissance absorbée 34 kW - 47 HP	puissance absorbée 41 kW - 55 HP
	VENTOLA	radiale in acciaio chiusa D.550 mm - 3500 giri/min. - portata aria: 12500 m <sup>3</sup> /h - velocità aria: 150 m/s	radiale in acciaio chiusa D.550 mm - 3700 giri/min. - portata aria: 14000 m <sup>3</sup> /h - velocità aria: 170 m/s	radiale in acciaio chiusa D.550 mm - 3900 giri/min. - portata aria: 15500 m <sup>3</sup> /h - velocità aria: 180 m/s
	TURBINE	diamètre 550 mm, fermée, en acier 3500 t/mn - débit d'air: 12500 m <sup>3</sup> /h vitesse d'air: 150 m/s	diamètre 550 mm, fermée, en acier 3700 t/mn - débit d'air: 14000 m <sup>3</sup> /h vitesse d'air: 170 m/s	diamètre 550 mm, fermée, en acier 3900 t/mn - débit d'air: 15500 m <sup>3</sup> /h vitesse d'air: 180 m/s
	POMPA	centrifuga di alimentazione e agitazione CIMA CD 32 - 4250 giri/min. - portata 140 l/min. pressione massima 4,5 kg/cm <sup>2</sup>		
	POMPE	centrifuge CIMA CD 32 - 4250 t/mn - débit max 140 l/mn pression max 4,5 kg/cm <sup>2</sup>		

Valori suscettibili di variazioni in funzione del dispositivo di distribuzione utilizzato  
Valeurs indicatives qui peuvent changer en fonction de l'équipement de distribution utilisé.

		<b>I. 1000</b>	<b>I. 1500</b>	<b>I. 2000</b>
	LUNGHEZZA	337-387 cm	412-462 cm	412-462 cm
	LONGUEUR			
	LARGHEZZA	140-185 cm	167-212 cm	170-215 cm
	LARGEUR			
	ALTEZZA	144-156 cm	146-158 cm	173-185 cm
	HAUTEUR			
	PESO	545 kg	676 kg cm	705 kg
	POIDS			
	RUOTE	10.0/75.15,3	10.0/75.15,3	11.5/80.15,3
	ROUES			

Le dimensioni e pesi sono a titolo indicativo e possono variare secondo la configurazione della macchina  
Les dimensions et poids sont à titre indicatif et peuvent varier suivant la configuration de la machine

Nei paesi dell'Unione Europea le nostre attrezzature sono conformi alla Direttiva Europea "Macchine"; negli altri paesi sono conformi alle norme di sicurezza in vigore in quei paesi.



Dans les pays de l'Union Européenne, nos équipements sont conformes à la Directive Européenne "Machines"; dans les autres pays ils sont conformes aux prescriptions de sécurité en vigueur dans ces pays.

# cima®



RIVENDITORE AUTORIZZATO - CONCESSIONAIRE

Loc. Molino Quaroni n.7, Montù Beccaria - PV - (ITALY)  
Tel. +39.0385.246636 - www.cima.it

