

cima[®]

ATOMIZZATORI-IMPOLVERATORI

Link 50 - 55



ATOMIZZATORI PNEUMATICI A BASSO VOLUME
ATOMIZADOR BAJO VOLUMEN NEUMÁTICO

Atomizzatori - Atomizadores



☆ Ampia scelta di testate di distribuzione, tutte dotate del nuovo sistema anti-sgocciolamento (brev. N° 1745689) e di dispositivi di diffusione (mani e/o cannoni) di diverse dimensioni, **orientabili ed intercambiabili** per garantire, su tutte le tipologie di colture, un'eccellente copertura e penetrazione nella vegetazione.

☆ Amplia gama de cabezales de distribución, todos equipados con el nuevo sistema antigoteo (pat. N.º 1745689) y dispositivos de difusión (manos y/o cañones) de diferentes dimensiones, **orientables e intercambiables**, para garantizar una excelente cobertura y penetración en cualquier tipo de cultivo.



☆ **Regolatori a disco rotante con 15 fori calibrati** (brev. N° 23238), sostituiscono il sistema a pastiglie. **Erogazione da 70 a 5000 litri/ora.**

☆ **Reguladores de disco giratorio con 15 orificios calibrados** (pat. N.º 23238) sustituyen el sistema de pastillas. **Distribución de 70 a 5000 l/h**

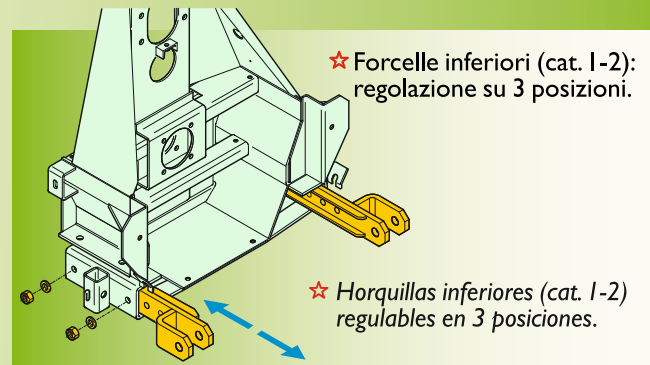

☆ **Lo snodo** consente all'atomizzatore di sterzare con raggi limitatissimi **senza cardano omocinetico** e grazie alle differenti regolazioni (←→), **le ruote del carrello passano sul tracciato di quelle della trattrice** (brev. N° 1312881)

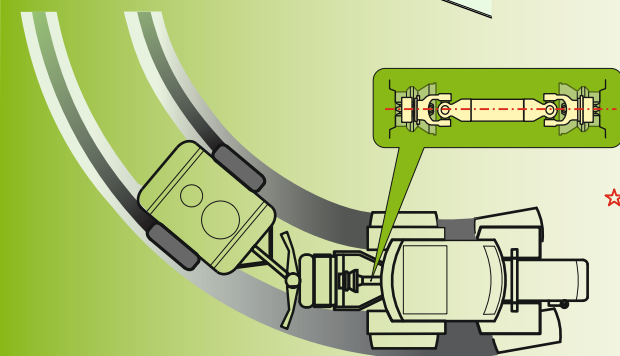

☆ **La articulación** permite al atomizador girar con radios sumamente reducidos, **sin cardán homocinético**; gracias a las diferentes regulaciones (←→) **las ruedas del carro pasan sobre la huella de las del tractor** (pat. N.º 1312881).

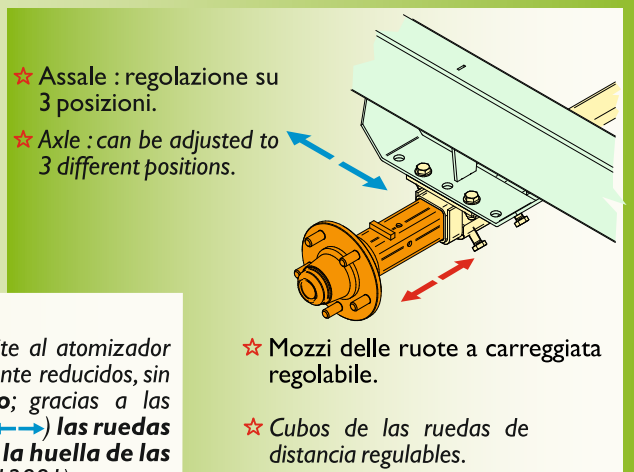

Link 50 - 55

☆ Serbatoio in polietilene rotazionale, apertura di riempimento di grandi dimensioni (ø460) con coperchio a cerniera, indicatori di livello. Serbatoio lavamani 1.30.



☆ Telaio snodato in acciaio, verniciatura elettrostatica con polvere poliester.

☆ **Idromiscelatore integrato nel filtro a tazza.**

☆ **Doppia agitazione, idraulica e pneumatica.**

☆ Ventola centrifuga chiusa ad alta pressione, in acciaio, con disinnesto; carter in polietilene rotazionale.

☆ Controllo dal posto operatore dell'erogazione con due elettrovalvole.

☆ Il serbatoio lavaimpianto (a richiesta), se mantenuto pieno, conferisce un'ottima stabilità anche a macchina vuota, essendo collocato al di sotto del serbatoio principale.



☆ Tanque rotomoldeado de polietileno; abertura de llenado de grandes dimensiones (ø460) con tapa engoznada e indicadores de nivel. Tanque para el lavado de las manos 1.30.

☆ Bastidor de acero; pintura electrostática con polvo poliéster.

☆ **Hidromezcladora integrada en el filtro de taza.**

☆ **Doble agitación, hidráulica y neumática.**

☆ Ventilador centrífugo cerrado de alta presión de acero, con desacoplamiento; cárter rotomoldeado de polietileno.

☆ Control de la distribución desde el puesto del operador, con dos electroválvulas.

☆ Si se mantiene lleno, el tanque para el lavado de la instalación (opcional) garantiza una óptima estabilidad incluso con la máquina vacía, ya que está situado debajo del tanque principal.



☆ Manometro (ø100) ben visibile dal posto operatore.

☆ Regolatore di pressione manuale (a comando elettrico dal posto operatore a richiesta).

☆ Filtro di grande portata : 240 l/min.



☆ Regulador de presión manual (mando eléctrico desde el puesto del operador opcional).

☆ Manómetro (ø100) bien visible desde el puesto del operador.

☆ Filtro de gran caudal: 240 l/min.



☆ **La pompa centrifuga di fabbricazione C.I.M.A. (senza membrane e valvole) costruita in materiale anticorrosivo è esente da manutenzione.** La cinghia di trasmissione 3V è dotata di tenditore automatico.



☆ **La bomba centrifuga CIMA (sin membranas ni válvulas), de material anticorrosivo, es libre de mantenimiento.** La correa de transmisión 3V está dotada de tensor automático.

☆ **Trasmissione a cinghia poly-V che assorbe le sollecitazioni. Funzionamento per oltre 5000 ore.** Il tenditore automatico evita lo slittamento e quindi l'usura. La qualità della polverizzazione resta inalterata nel tempo.

☆ **Ruota libera di sicurezza per arresti improvvisi.**

☆ **Transmisión con correa poly-V, que absorbe los esfuerzos. Funcionamiento por más de 5000 horas.**

El tensor automático evita el deslizamiento y, en consecuencia, el desgaste. La calidad de la pulverización permanece inalterada en el tiempo.

☆ **Rueda libre de seguridad para paradas repentinas.**



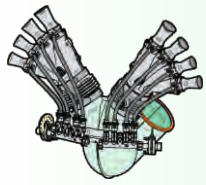

T.4+4
Link 50 (T.4+4.50P)

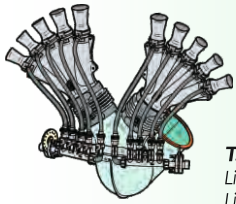
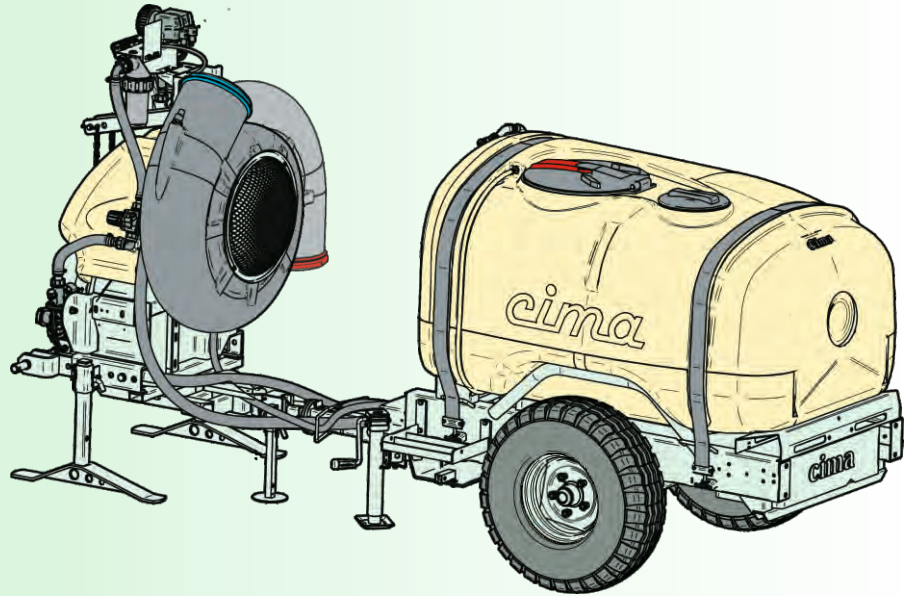
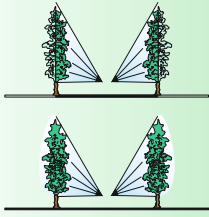

T.5+5
Link 50 (T.5+5.50P)
Link 55 (T.5+5.55S)

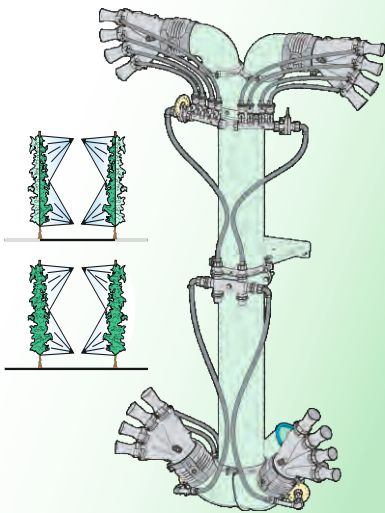
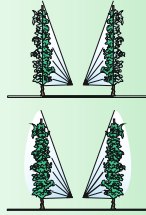

TC.2M2M
Link 50 (TC.2M2M.50P)

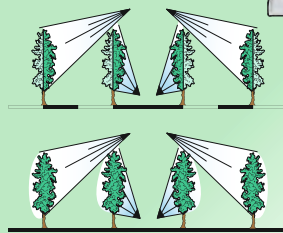
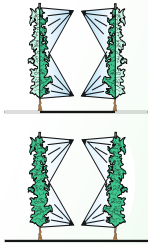

TC.2M2C
Link 50 (TC.2M2C.50P)
Link 55 (TC.2M2C.55S)

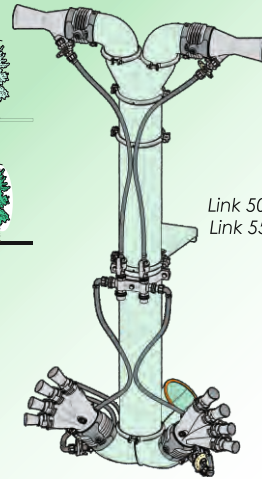

TC.4M2C
Link 50 (TC.4M2C.50P)
Link 55 (TC.4M2C.55S)

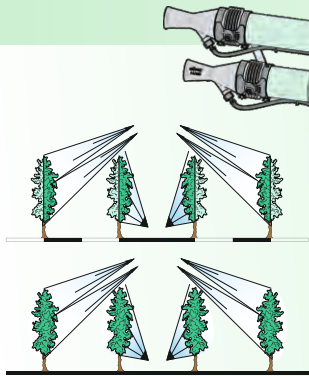
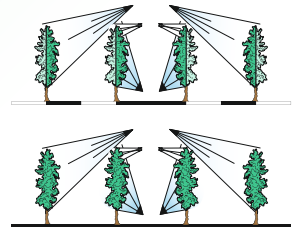
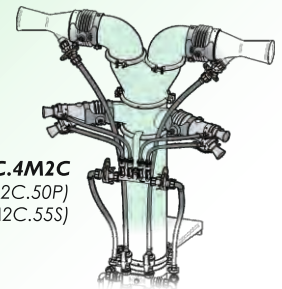

TC.2M4C
Link 50 (TC.2M4C.50P)
Link 55 (TC.2M4C.55S)

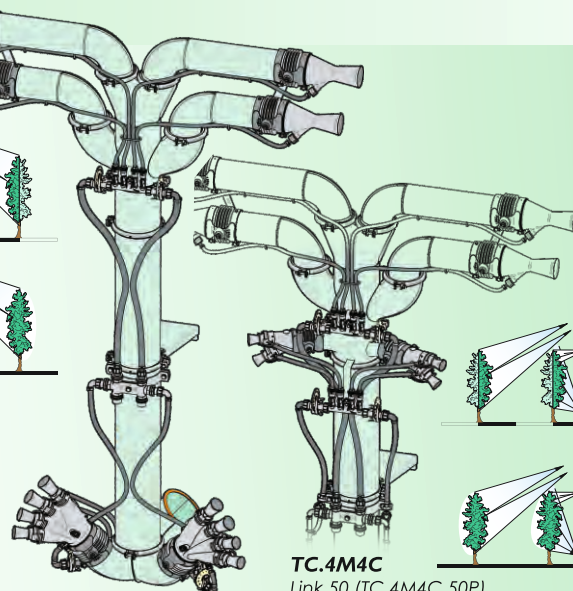

TC.4M4C
Link 50 (TC.4M4C.50P)
Link 55 (TC.4M4C.55S)

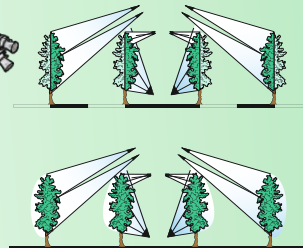

TESTATE -

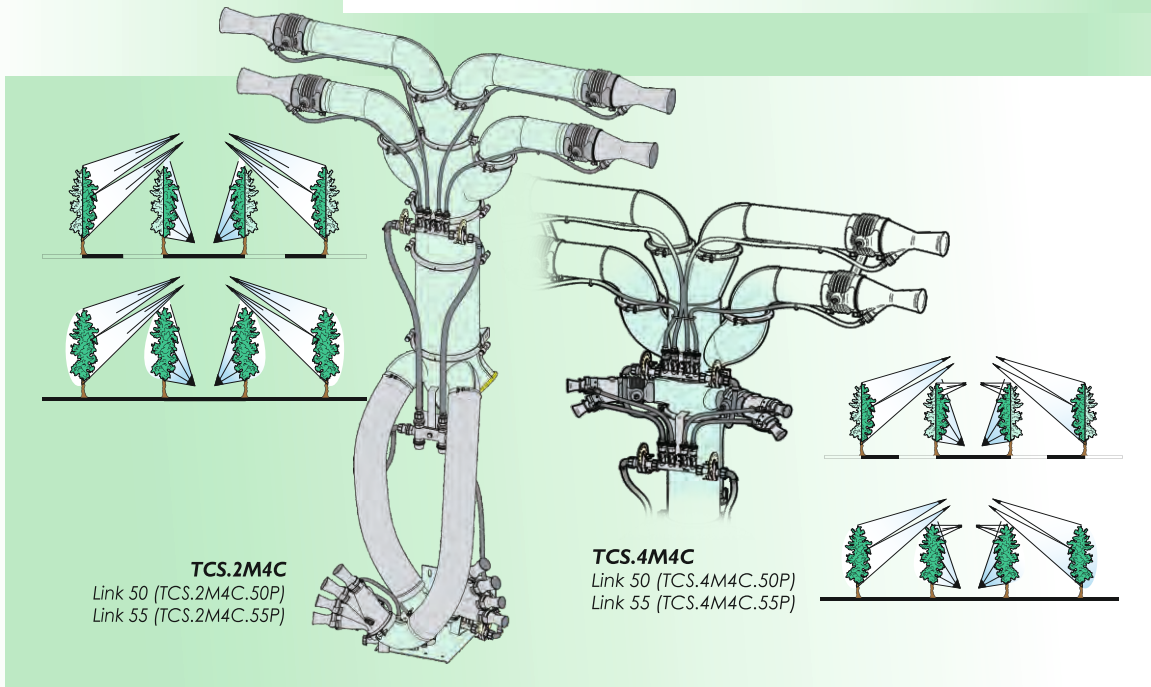
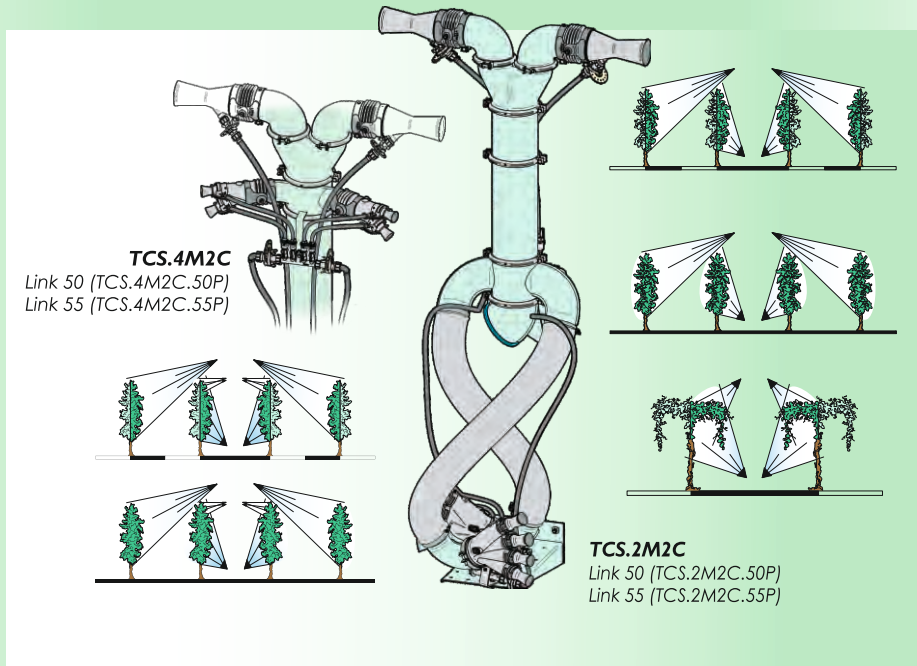
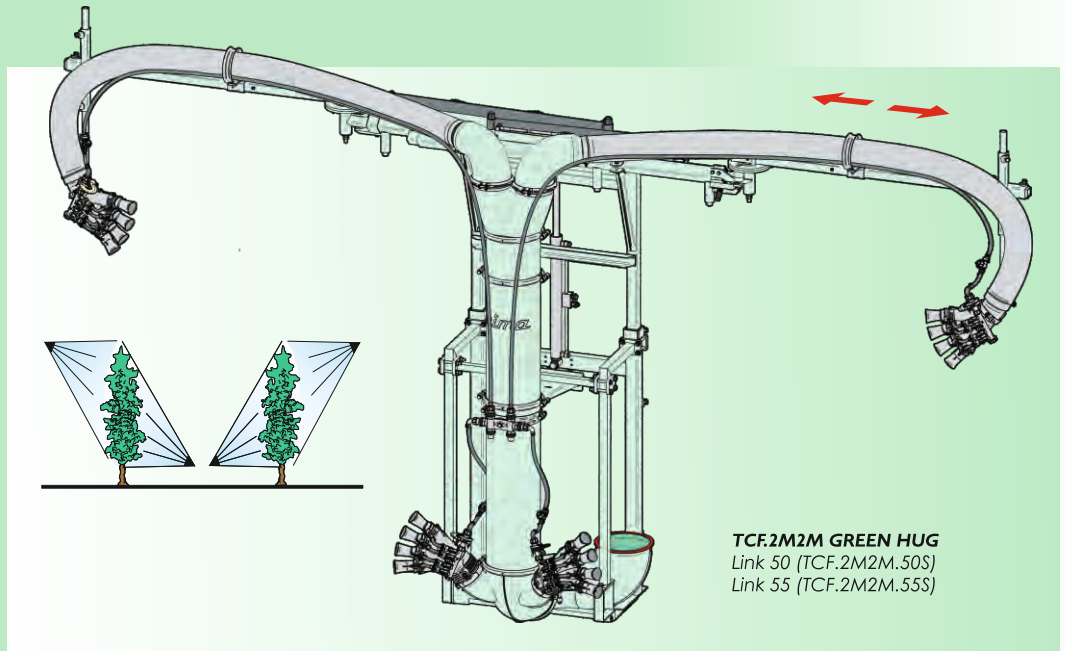

CABEZALES

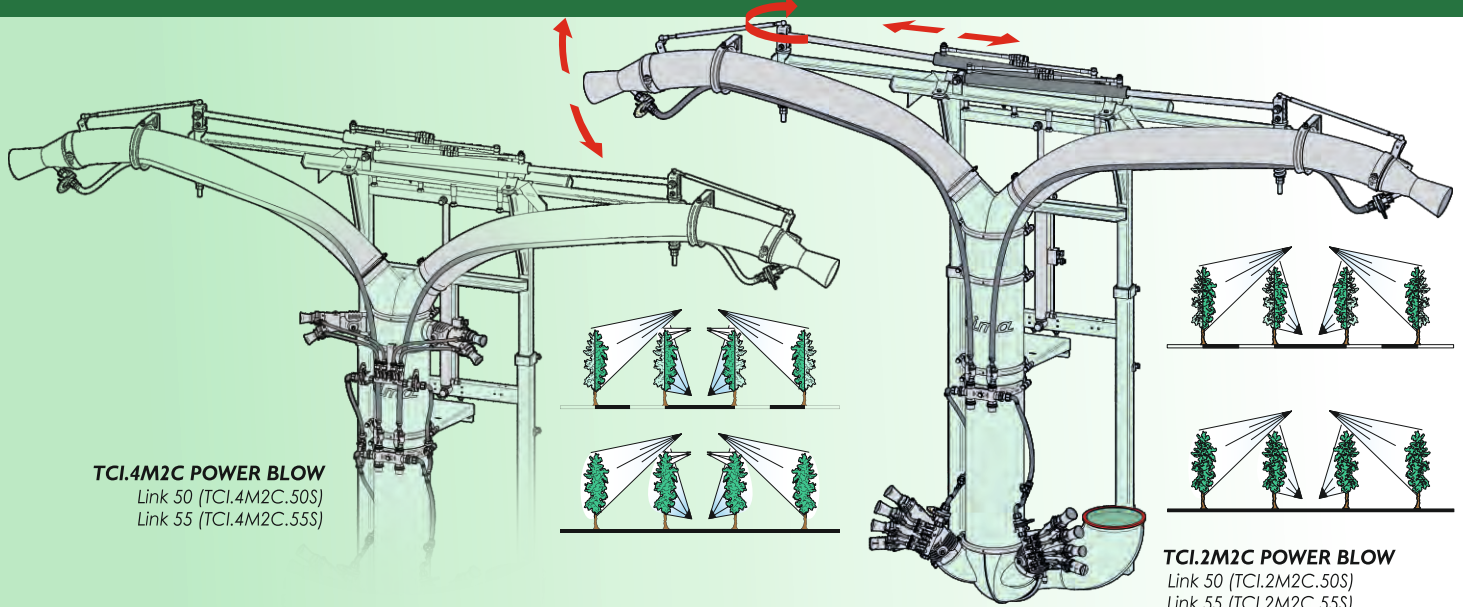

TCI.4M2C POWER BLOW
 Link 50 (TCI.4M2C.50S)
 Link 55 (TCI.4M2C.55S)

TCI.2M2C POWER BLOW
 Link 50 (TCI.2M2C.50S)
 Link 55 (TCI.2M2C.55S)

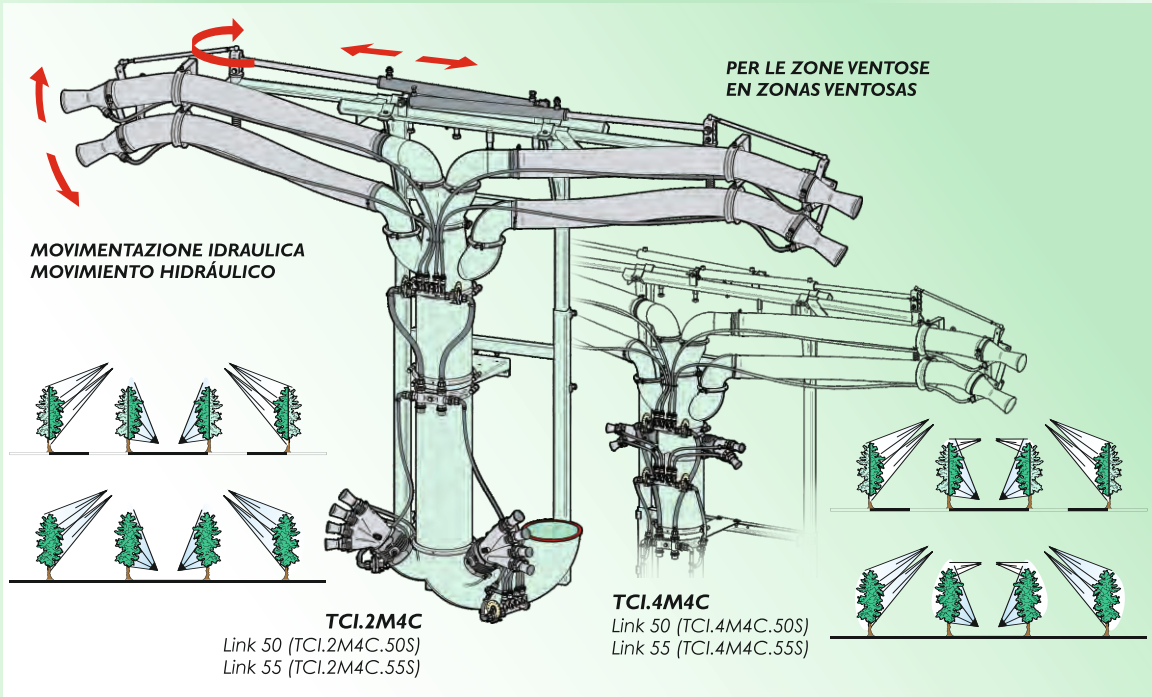

MOVIMENTAZIONE IDRAULICA
 MOVIMIENTO HIDRÁULICO

PER LE ZONE VENTOSE
 EN ZONAS VENTOSAS

TCI.2M4C
 Link 50 (TCI.2M4C.50S)
 Link 55 (TCI.2M4C.55S)

TCI.4M4C
 Link 50 (TCI.4M4C.50S)
 Link 55 (TCI.4M4C.55S)

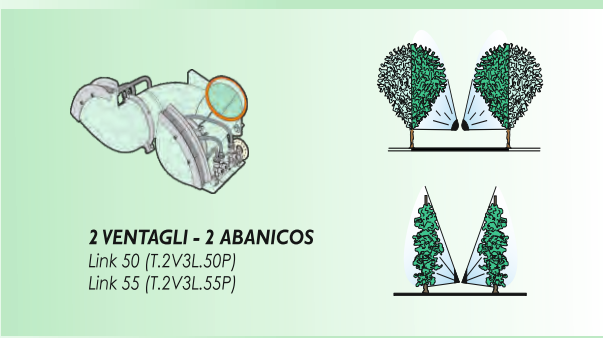

2 VENTAGLI - 2 ABANICOS
 Link 50 (T.2V3L.50P)
 Link 55 (T.2V3L.55P)

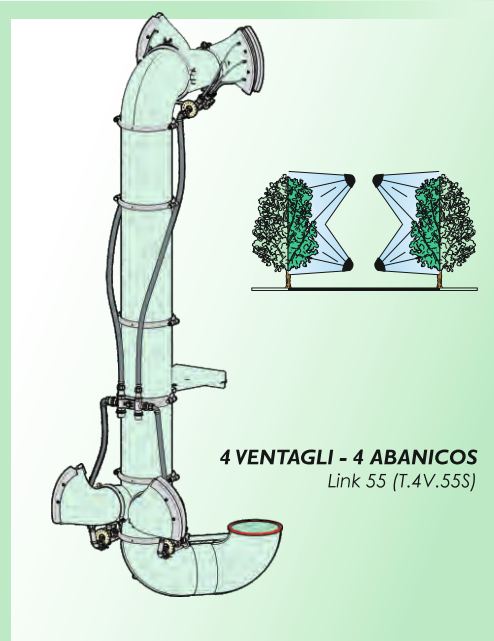

4 VENTAGLI - 4 ABANICOS
 Link 55 (T.4V.55S)

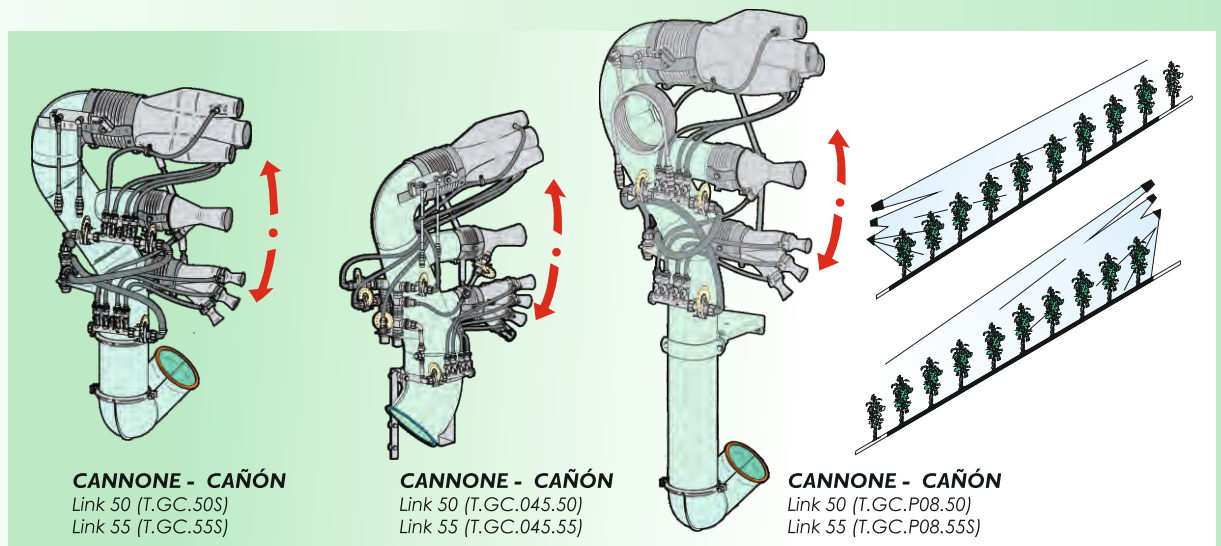
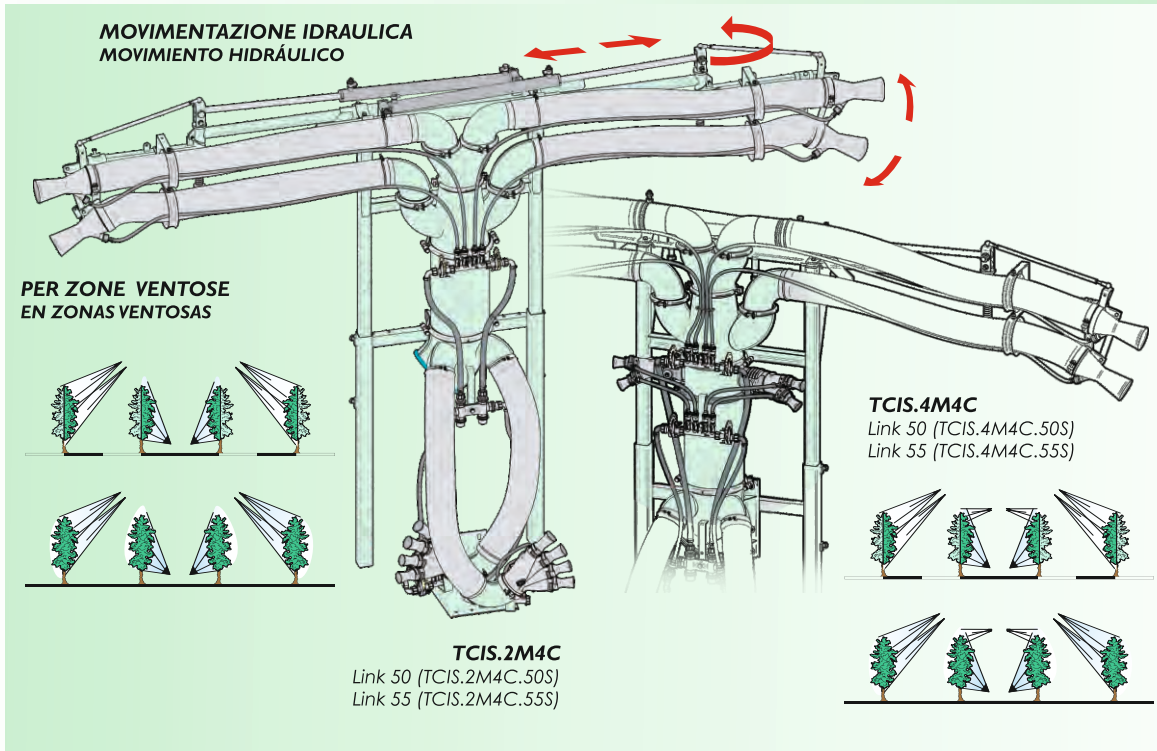
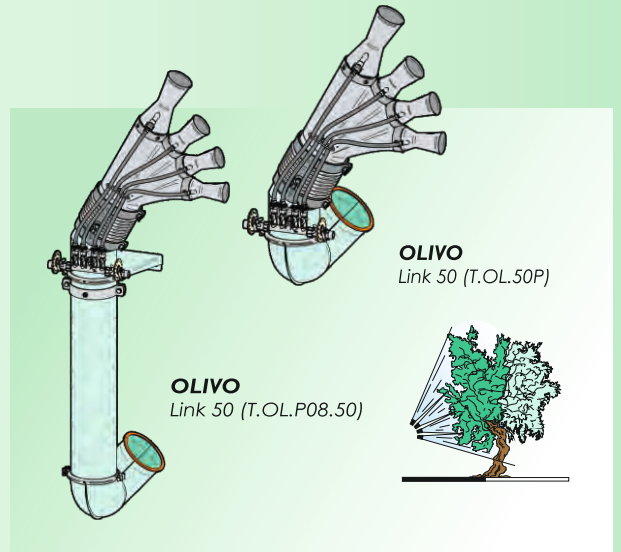

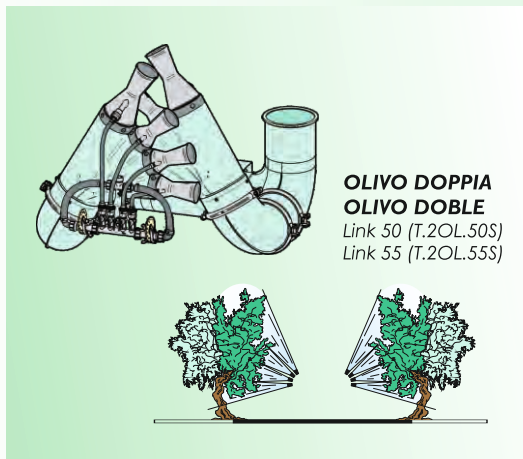

**OLIVO DOPPIA
OLIVO DOBLE**
Link 50 (T.2OL.50S)
Link 55 (T.2OL.55S)

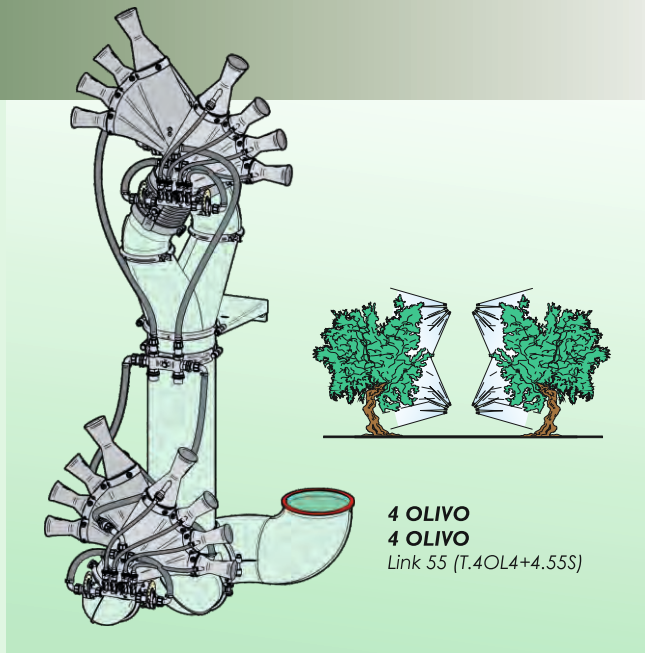

**4 OLIVO
4 OLIVO**
Link 55 (T.4OL4+4.55S)

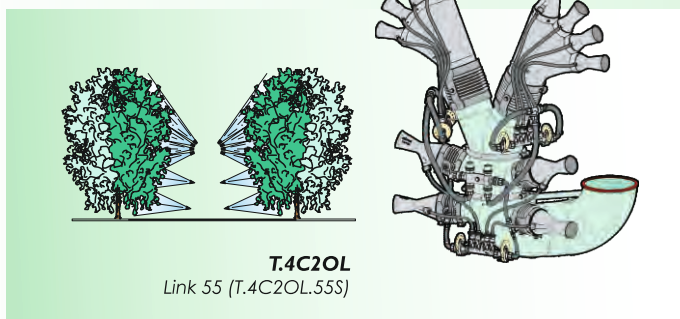

T.4C2OL
Link 55 (T.4C2OL.55S)

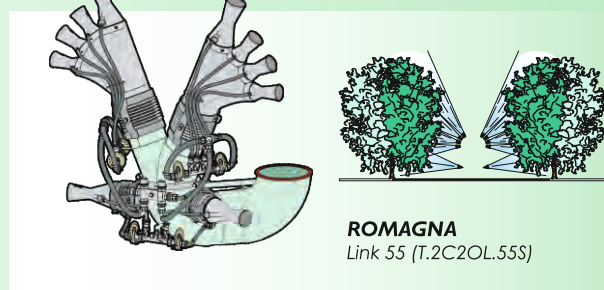

ROMAGNA
Link 55 (T.2C2OL.55S)

ACCESSORI - ACCESORIOS DISPONIBILES

KIT PISTONI IDRAULICI KIT DE PISTONES HIDRÁULICOS

disponibile per:
disponible para:
T.4+4
T.5+5
T.OL

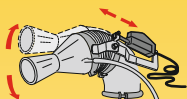
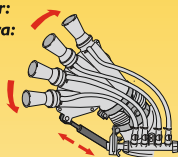

KIT PISTONI ELETTRICI KIT DE PISTONES ELÉCTRICOS

(solo cannoni superiori)
(solo para cañones superiores)



GRUPPO 2 ELETTROVALVOLE SUPPLEMENTARI GRUPO 2 ELECTROVÁLVULAS ADICIONALES

Link 50-55 (D.4E.P11)

REGOLATORE ELETTRICO PRESSIONE REGULADOR ELÉCTRICO DE PRESIÓN

Link 50 - 55 (D.V.S01)

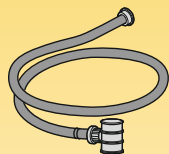
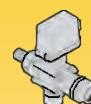

TUBAZIONE RIEMPIMENTO TUBO DE LLENADO

Link (TUBAZ.RIEMP)



COLLARE - COLLARES

Link 50 D-175mm (X05.616.000)
Link 55 D-250mm (X05.813.000)



SENSORI ULTRASUONI SENSORES ULTRASONÍCOS

Link 50-55 (D.SU2.EPA.S02)



KIT EASY FARM KIT EASY FARM

Link 50-55 (K.EASYFARM.01)

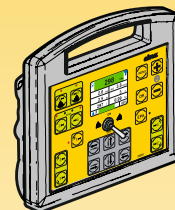

E.P.A. 2.0

Erogazione Proporzionale Avanzamento
Distribución Proporcional de Avance

Link 50 - 55 (EPA.S11)

KIT LUCI POSTERIORI KIT DE LUCES TRASERAS

Link 50-55 (KIT.LP.10.03)

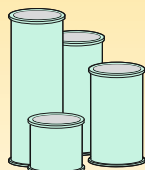
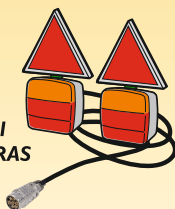

PROLUNGHE - ALGADERAS

Link 50 D-175mm
200mm (X02.186.000) - 400mm (X02.187.000)
600mm (X02.188.000) - 800mm (X02.189.000)

Link 55 D-250mm
200mm (X21.100.020) - 400mm (X21.100.040)
600mm (X21.100.060) - 800mm (X21.100.080)

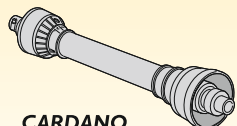

CARDANO CARDÁN

Link 50-55 (KHP.060.090)

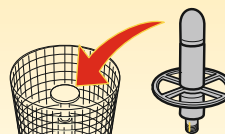

LAVABARATTOLI DISPOSITIVO DE LAVADO DE CONTENEDORES (KIT.LAV.BOX)

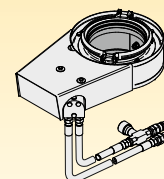



GIREVOLE IDRAULICO GIRATORIO HIDRÁULICO

Link 50 (T.GIR.I.175P)
Link 55 (T.GIR.I.250P)

Alcuni accessori sono forniti di serie in certi paesi - Algunos accesorios se suministran de serie en determinados países

INFORMAZIONI TECNICHE

INFORMACIÓN TÉCNICA

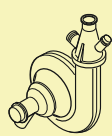
		Link 50 N	Link 50 S	Link 55 N	Link 55 S	Link 55 E
	TRATTRICE	potenza richiesta 48 kW - 65 CV	potenza richiesta 52 kW - 70 CV	potenza richiesta 52 kW - 70 CV	potenza richiesta 58 kW - 80 CV	potenza richiesta 66 kW - 90 CV
	TRACTOR	potencia requerida 48 kW - 65 CV	potencia requerida 52 kW - 70 CV	potencia requerida 52 kW - 70 CV	potencia requerida 58 kW - 80 CV	potencia requerida 66 kW - 90 CV
	ATOMIZZATORE	potenza assorbita 24 kW - 33 CV	potenza assorbita 26 kW - 36 CV	potenza assorbita 26 kW - 36 CV	potenza assorbita 34 kW - 47 CV	potenza assorbita 41 kW - 55 CV
	ATOMIZADOR	potencia absorbida 24 kW - 33 CV	potencia absorbida 26 kW - 36 CV	potencia absorbida 26 kW - 36 CV	potencia absorbida 34 kW - 47 CV	potencia absorbida 41 kW - 55 CV
		radial de acero cerrada D. 500 mm			radial de acero cerrada D. 550 mm	
	VENTOLA	4000 giri/min. portata aria: 7550 m ³ /h velocità aria: 175 m/s	4210 giri/min. portata aria: 8300 m ³ /h velocità aria: 180 m/s	3500 giri/min. portata aria: 12500 m ³ /h velocità aria: 150 m/s	3700 giri/min. portata aria: 14000 m ³ /h velocità aria: 170 m/s	3900 giri/min. portata aria: 15500 m ³ /h velocità aria: 180 m/s
	VENTILADOR	4000 rpm caudal de aire: 7550 m ³ /h velocidad del aire: 175 m/s	4210 rpm caudal de aire: 8300 m ³ /h velocidad del aire: 180 m/s	3500 rpm caudal de aire: 12500 m ³ /h velocidad del aire: 150 m/s	3700 rpm caudal de aire: 14000 m ³ /h velocidad del aire: 170 m/s	3900 rpm caudal de aire: 15500 m ³ /h velocidad del aire: 180 m/s
	POMPA	centrifuga di alimentazione e agitazione CIMA CD 32 - 4250 giri/min. portata massima 140 l/min. - pressione massima 4,5 kg/cm ²				
	BOMBA	centrifuga de alimentación y agitación CIMA CD 32 - 4250 rpm caudal 140 l/min - presión máx. 4,5 kg/cm ²				

Valori suscettibili di variazioni in funzione del dispositivo di distribuzione utilizzato
Valores susceptibles de variación en función del dispositivo de distribución utilizado.

		Link 50				Link 55			
		I. 800	I. 1000	I. 1000 stretto - estrecho	I. 1500	I. 800	I. 1000	I. 1000 stretto - estrecho	I. 1500
	LUNGHEZZA	322 cm	330 cm	322 cm	396 cm	322 cm	330 cm	322 cm	396 cm
	LONGITUD								
	LARGHEZZA	109-135 cm	140-165 cm	113-139 cm	163-210 cm	109-135 cm	140-165 cm	113-139 cm	163-210 cm
	ANCHO								
	ALTEZZA	169 cm	172 cm	169 cm	170 cm	169 cm	172 cm	169 cm	170 cm
	ALTURA								
	PESO	510 kg	540 kg	535 kg	668 kg	523 kg	553 kg	550 kg	683 kg
	PESO ESTÁNDAR								
	RUOTE	7.00-12	10/80-12	10/80-12	10/75-15,3	7.00-12	10/80-12	10/80-12	10/75-15,3
	RUEDAS	10/80-12 (opt.)	10/75-15,3 (opt.)	10/75-15,3 (opt.)		10/80-12 (opt.)	10/75-15,3 (opt.)	10/75-15,3 (opt.)	10/75-15,3

Le dimensioni e pesi sono a titolo indicativo e possono variare secondo la configurazione della macchina.
Los pesos y dimensiones son indicativos y pueden variar según la configuración de la máquina.

Nei paesi dell'Unione Europea le nostre attrezzature sono conformi alla Direttiva Europea "Macchine"; negli altri paesi sono conformi alle norme di sicurezza in vigore in quei paesi.



En los países de la Unión Europea, nuestros productos responden a la Directiva Europea "Máquinas"; en los demás países, responden a las normas de seguridad vigentes en los mismos.

cima[®]

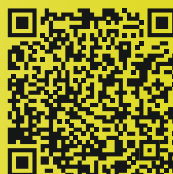

RIVENDITORE AUTORIZZATO
REVENDEDOR AUTORIZADO

Loc. Molino Quaroni n.7, Montù Beccaria - PV - (ITALY)
Tel. +39.0385.246636 - www.cima.it

