



cima[®]

ATOMIZZATORI-IMPOLVERATORI

Link 50 - 55



**ATOMIZZATORI PNEUMATICI A BASSO VOLUME
PNEUMATIQUES ARTICULÉS**

Atomizzatori - Pneumatiques



★ Ampia scelta di testate di distribuzione, tutte dotate del nuovo sistema anti-sgocciolamento (brev. N° 1745689) e di dispositivi di diffusione (mani e/o cannoni) di diverse dimensioni, **orientabili ed intercambiabili** per garantire, su tutte le tipologie di colture, un'eccellente copertura e penetrazione nella vegetazione.

★ Large choix d'équipements de pulvérisation, tous équipés du nouveau système antigoutte (brevet No.1745689) et des dispositifs de diffusion (mains et/ou canons) de dimensions différentes, **orientables et interchangeables**, pour garantir, à chaque type de culture, une meilleure pénétration et une couverture d'excellente qualité de la végétation.



★ **Regolatori a disco rotante** con 15 fori calibrati (brev. N° 23238), sostituiscono il sistema a pastiglie. **Erogazione da 70 a 5000 litri/ora.**

★ **Régulateurs à disques tournants** avec 15 trous calibrés (brevet No.23238) remplacent le système à pastilles. **Débit : de 70 à 5000 l/h.**

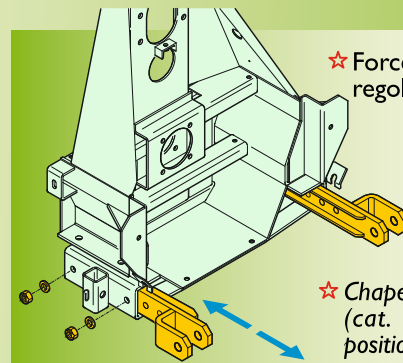

★ Forcelle inferiori (cat. 1-2): regolazione su 3 posizioni.

★ Chapes d'attelage inférieures (cat. 1-2): réglage sur 3 positions.

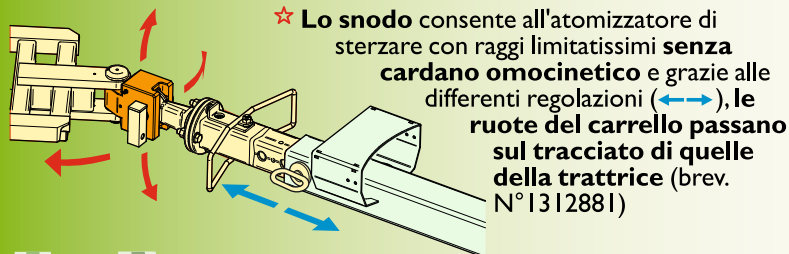

★ **Lo snodo** consente all'atomizzatore di sterzare con raggi limitatissimi **senza cardan omocinetico** e grazie alle differenti regolazioni (↔), **le ruote del carrello passano sul tracciato di quelle della trattrice** (brev. N° 1312881)

★ Assale: regolazione su 3 posizioni.
★ Essieu: réglage sur 3 positions.

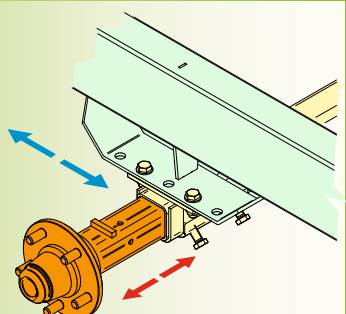

★ Mozzi delle ruote a carreggiata regolabile.

★ Moyeux des roues : réglables en largeur

★ **Le joint articulé** permet d'avoir un rayon de braquage très court **sans le cardan homocinétique** et grâce aux différentes régulations (↔), **les roues du chariot font le même tracé des roues du tracteur** (brevet No.1312881).

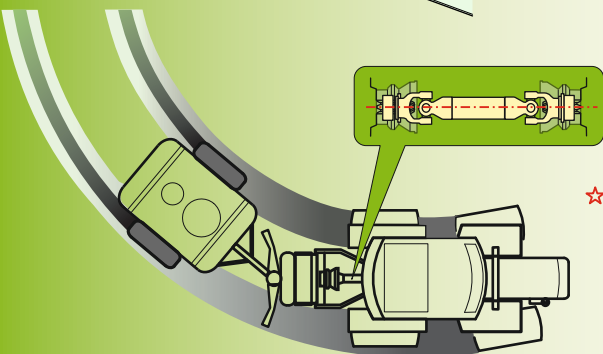

Link 50 - 55

- ☆ Serbatoio in polietilene rotazionale. Apertura di riempimento di grandi dimensioni (Ø460) con coperchio a cerniera, indicatori di livello. Serbatoio lavamani l.30.



- ☆ Telaio snodato in acciaio, verniciatura elettrostatica con polvere poliestere.

- ☆ Idromiscelatore integrato nel filtro a tazza.

- ☆ Doppia agitazione, idraulica e pneumatica.

- ☆ Ventola centrifuga chiusa ad alta pressione, in acciaio, con disinnesto; carter in polietilene rotazionale.

- ☆ Controllo dal posto operatore dell'erogazione con due elettrovalvole.

- ☆ Il serbatoio lavaimpianto (a richiesta), se mantenuto ce pieno, conferisce un'ottima stabilità anche a macchina vuota, essendo collocato al di sotto del serbatoio principale.



- ☆ Réservoir en polyéthylène rotomoulé. Large ouverture (Ø 460) avec couvercle articulé, jauges graduées. Réservoir lave-mains 30 litres.

- ☆ Châssis articulé en acier avec peinture polyester électrostatique.

- ☆ Tamis mélangeur intégré.

- ☆ Double agitation, hydro-pneumatique.

- ☆ Turbine centrifuge fermée haute pression, en acier, débrayable dans volute en polyéthylène rotomoulée.

- ☆ Contrôle du débit à télécommande électrique depuis le poste de conduite.

- ☆ La cuve de rinçage (en option) si pleine, placée au-dessous du réservoir de l'appareil, donne une excellente stabilité même à réservoir vide.



- ☆ Manometro (Ø100) ben visibile dal posto operatore.

- ☆ Regolatore di pressione manuale (a comando elettrico dal posto operatore a richiesta).

- ☆ Filtro di grande portata : 240 l/min.



- ☆ Manomètre (Ø 100), bien visible depuis le poste de conduite.

- ☆ Régulateur de pression manuel (en option à commande électrique depuis le poste de conduite).

- ☆ Filtre à grand débit: 240 lmn.

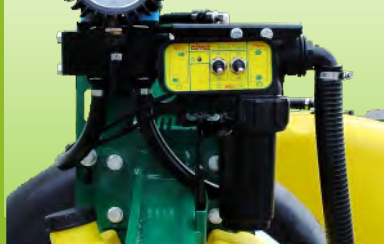

- ☆ La pompa centrifuga di fabbricazione C.I.M.A. (senza membrane e valvole) costruita in materiale anticorrosivo è esente da manutenzione. La cinghia di trasmissione 3V è dotata di tenditore automatico.



- ☆ La pompe centrifuge fabrication C.I.M.A. (sans membranes et clapets) produite en matériel anti-corrosion est fiable et sans entretien. Sa courroie de transmission 3V est équipée d'un tendeur automatique.

- ☆ Trasmissione a cinghia poly-V che assorbe le sollecitazioni. Funzionamento per oltre 5000 ore. Il tenditore automatico evita lo slittamento e quindi l'usura. La qualità della polverizzazione resta inalterata nel tempo.

- ☆ Ruota libera di sicurezza per arresti improvvisi.

- ☆ Transmission à courroie poly-V qui absorbe toutes tensions. Plus de 5000 heures de fonctionnement. Le tendeur automatique évite le glissement et l'usure. La qualité de la pulvérisation reste inaltérée longtemps.

- ☆ Roue libre de sécurité en cas d'arrêt soudain de la PdF (en option).



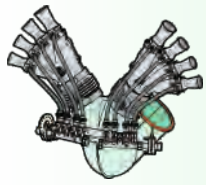

T.4+4
Link 50 (T.4+4.50P)

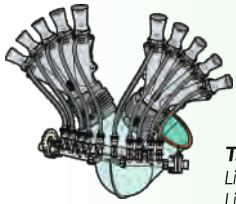
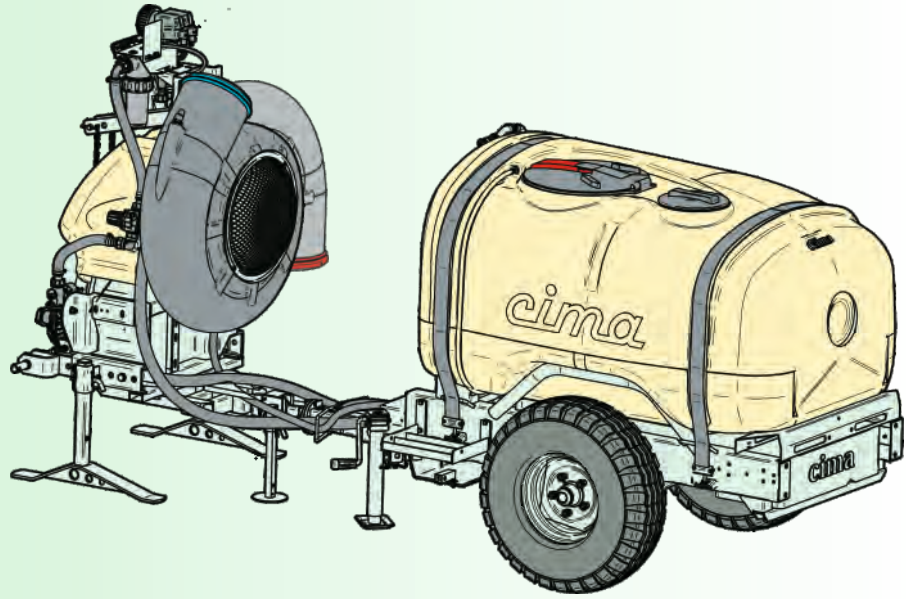
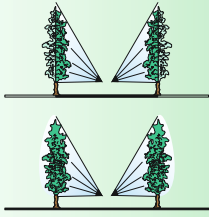

T.5+5
Link 50 (T.5+5.50P)
Link 55 (T.5+5.55S)

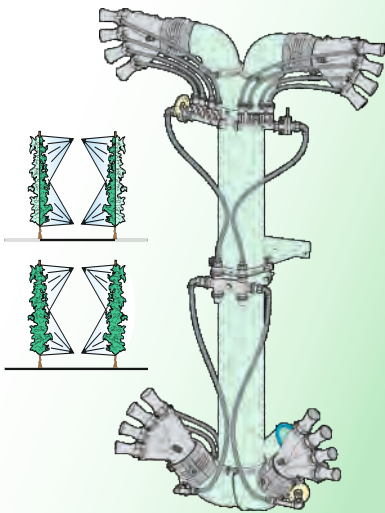
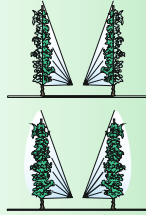

TC.2M2M
Link 50 (TC.2M2M.50P)

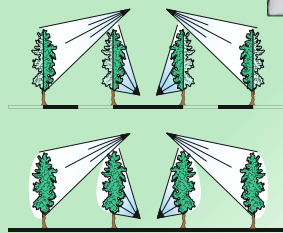
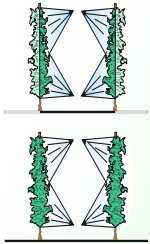

TC.2M2C
Link 50 (TC.2M2C.50P)
Link 55 (TC.2M2C.55S)

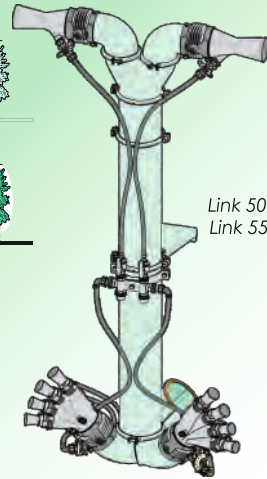

TC.4M2C
Link 50 (TC.4M2C.50P)
Link 55 (TC.4M2C.55S)

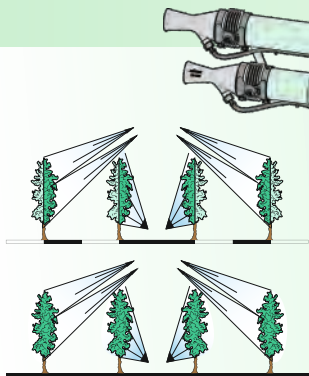
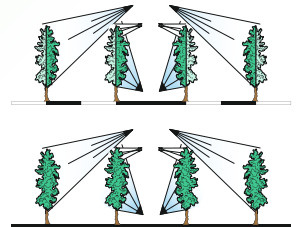
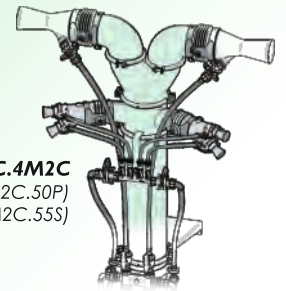

TC.2M4C
Link 50 (TC.2M4C.50P)
Link 55 (TC.2M4C.55S)

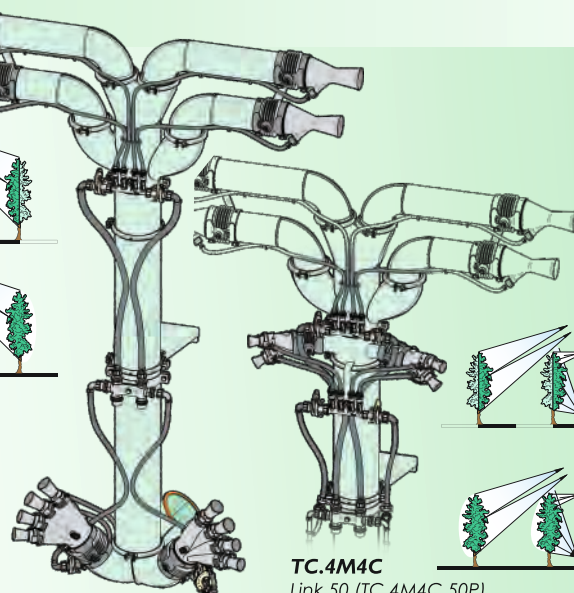

TC.4M4C
Link 50 (TC.4M4C.50P)
Link 55 (TC.4M4C.55S)

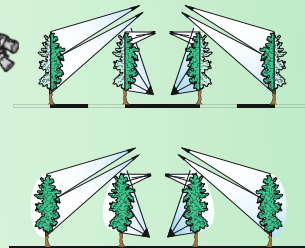

TESTATE -

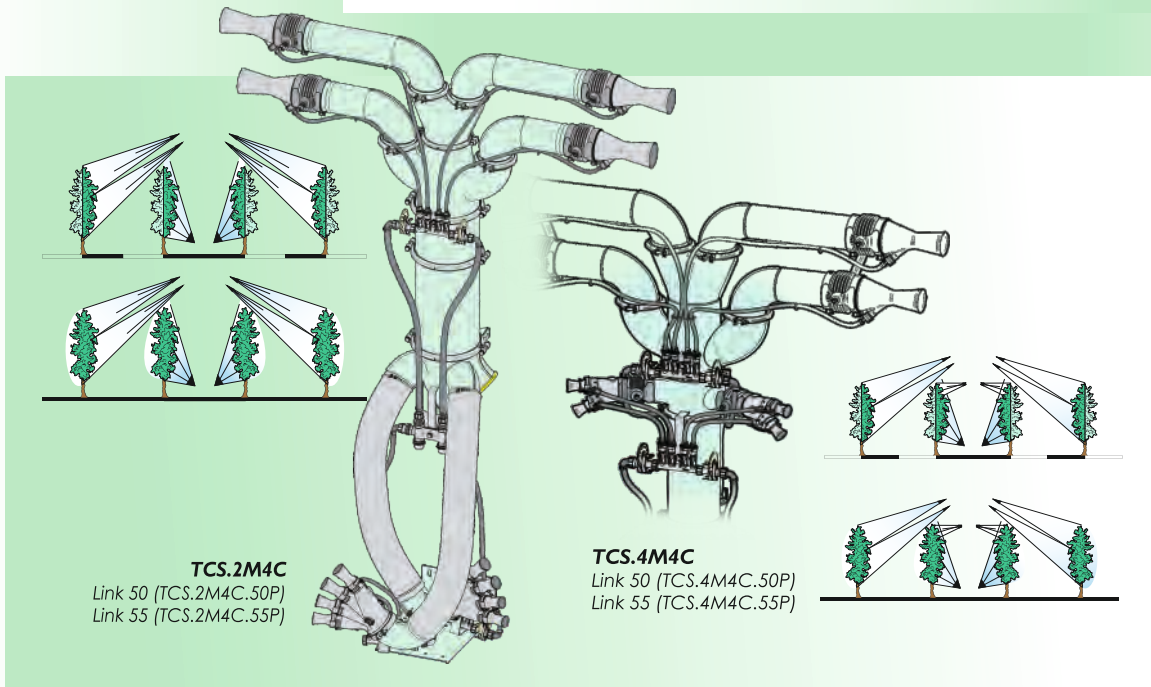
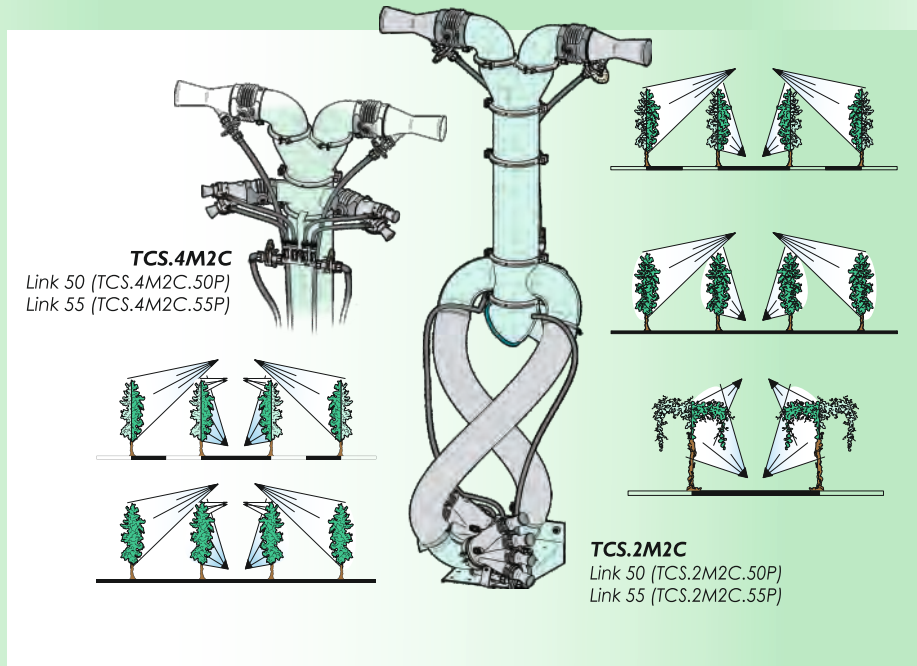
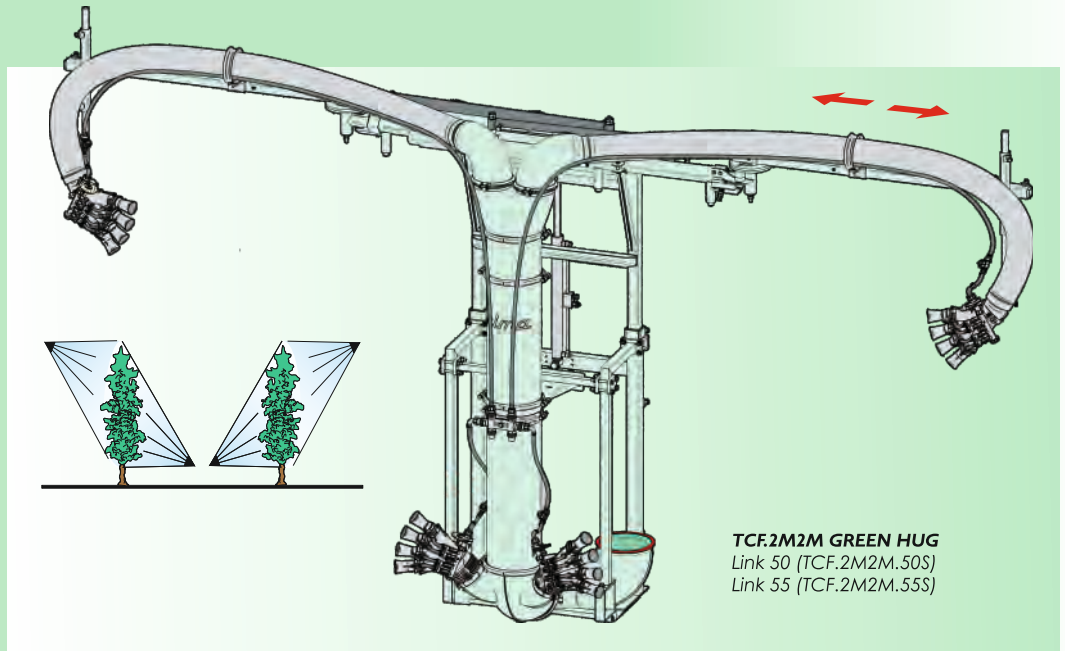

EQUIPEMENTS DE

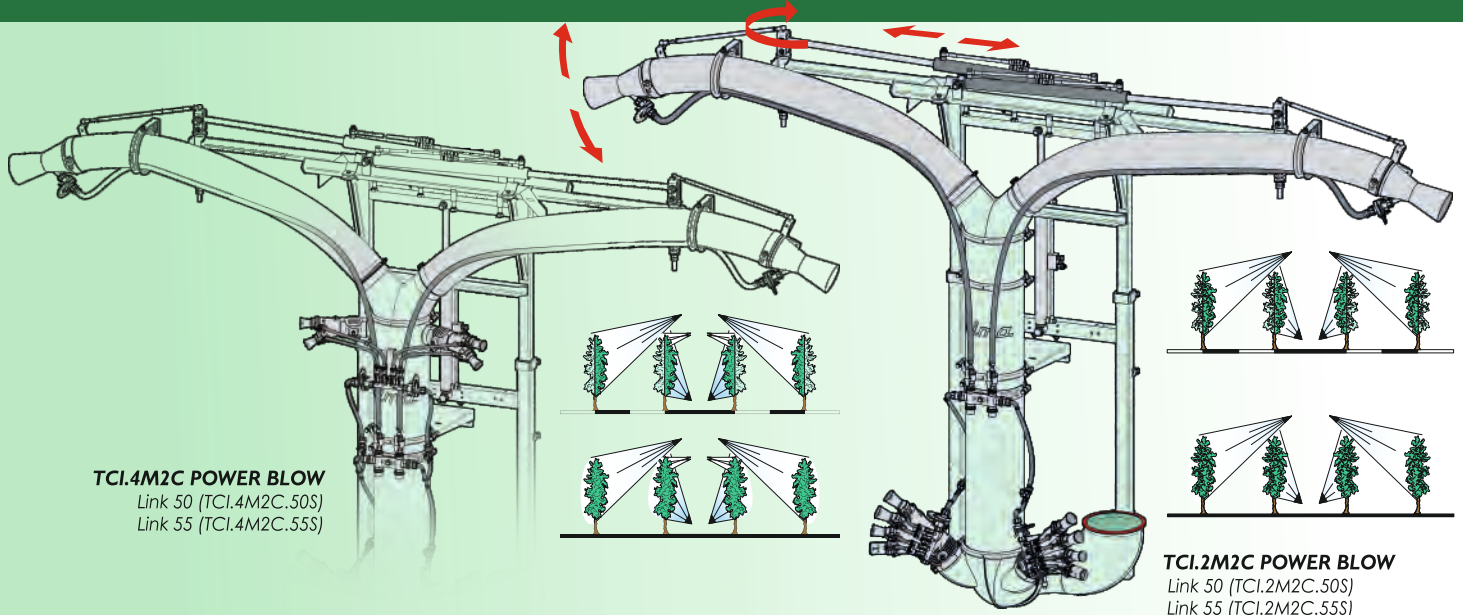

TCI.4M2C POWER BLOW
 Link 50 (TCI.4M2C.50S)
 Link 55 (TCI.4M2C.55S)

TCI.2M2C POWER BLOW
 Link 50 (TCI.2M2C.50S)
 Link 55 (TCI.2M2C.55S)

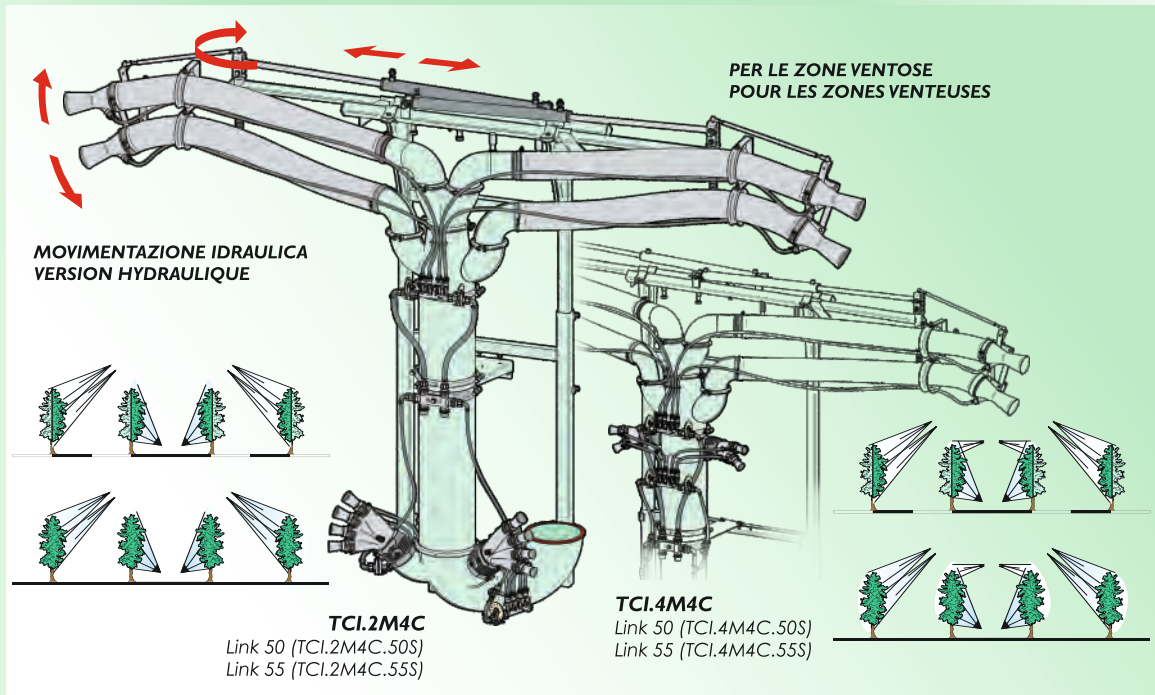

**MOVIMENTAZIONE IDRAULICA
 VERSION HYDRAULIQUE**

**PER LE ZONE VENTOSE
 POUR LES ZONES VENTEUSES**

TCI.2M4C
 Link 50 (TCI.2M4C.50S)
 Link 55 (TCI.2M4C.55S)

TCI.4M4C
 Link 50 (TCI.4M4C.50S)
 Link 55 (TCI.4M4C.55S)

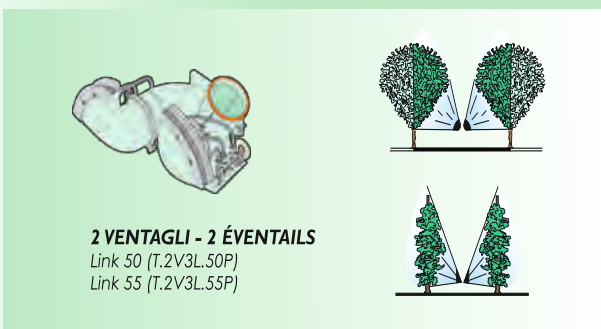

2 VENTAGLI - 2 ÉVENTAILS
 Link 50 (T.2V3L.50P)
 Link 55 (T.2V3L.55P)

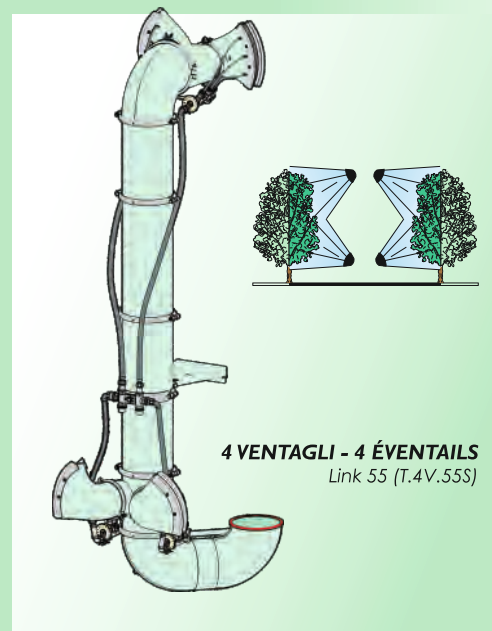

4 VENTAGLI - 4 ÉVENTAILS
 Link 55 (T.4V.55S)

DISTRIBUTION

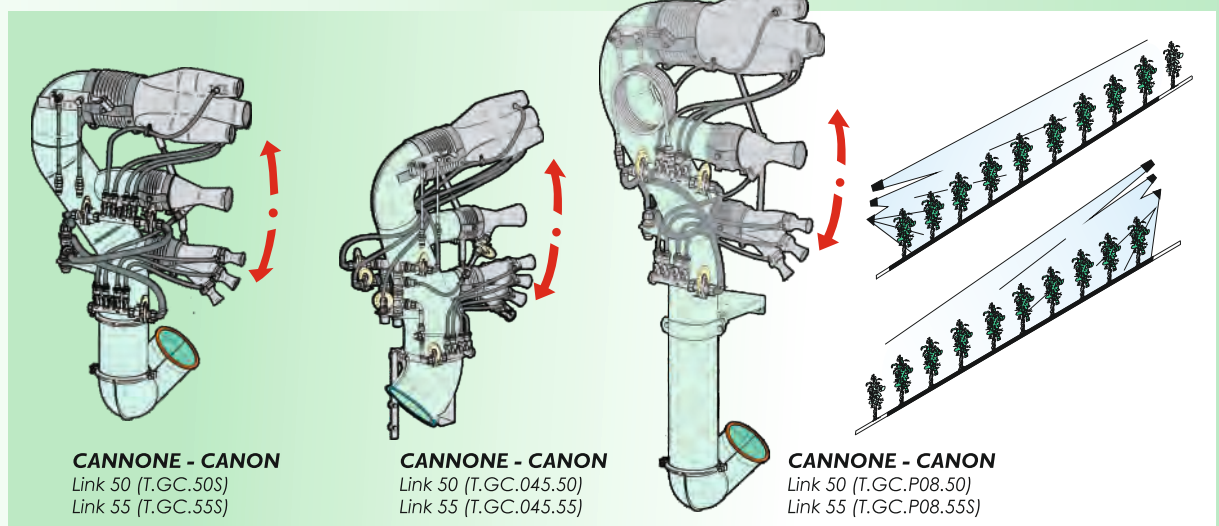
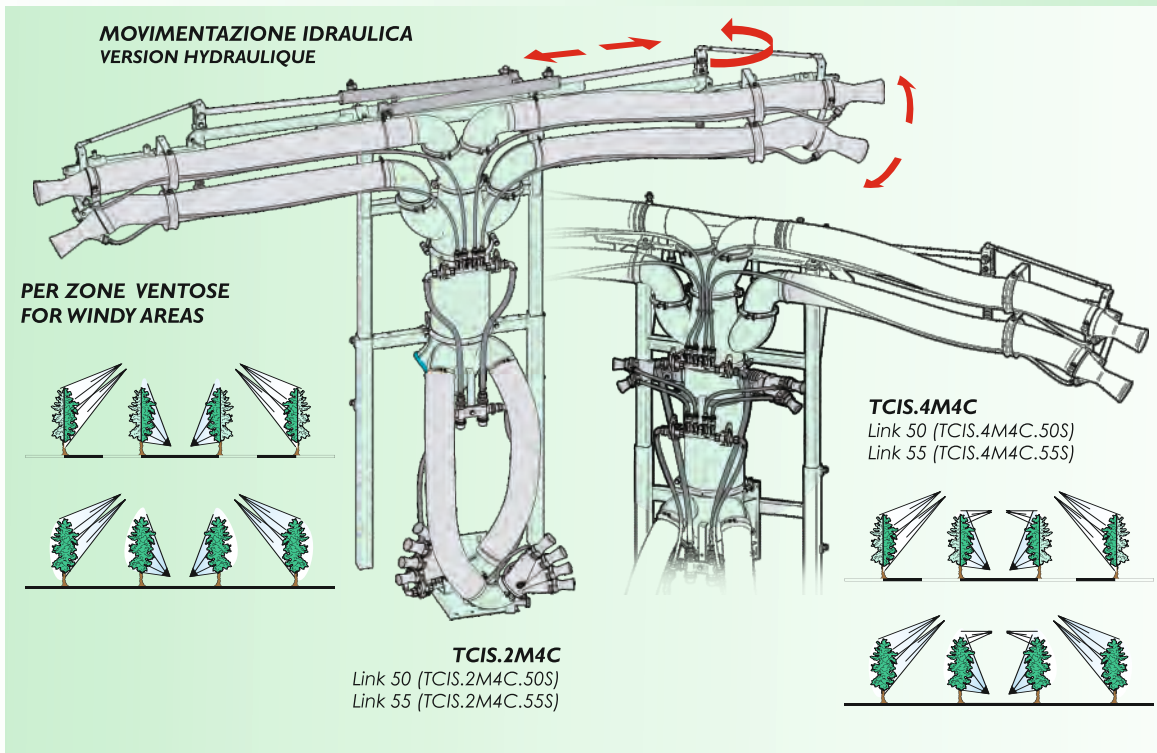
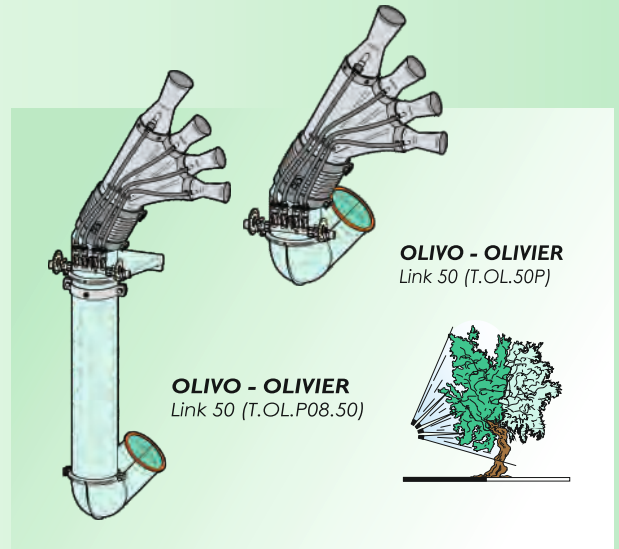

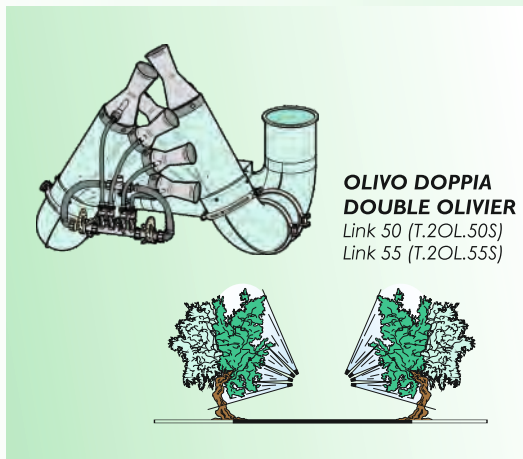

**OLIVO DOPPIA
DOUBLE OLIVIER**
Link 50 (T.2OL.50S)
Link 55 (T.2OL.55S)

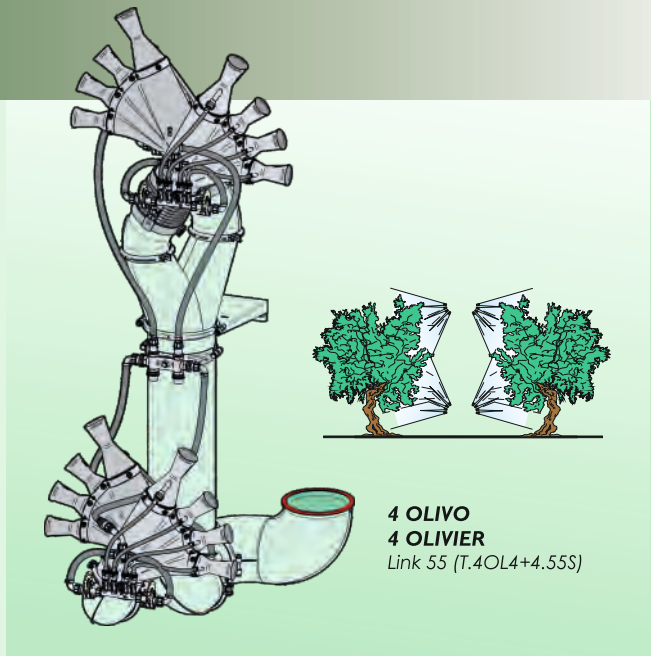

**4 OLIVO
4 OLIVIER**
Link 55 (T.4OL4+4.55S)

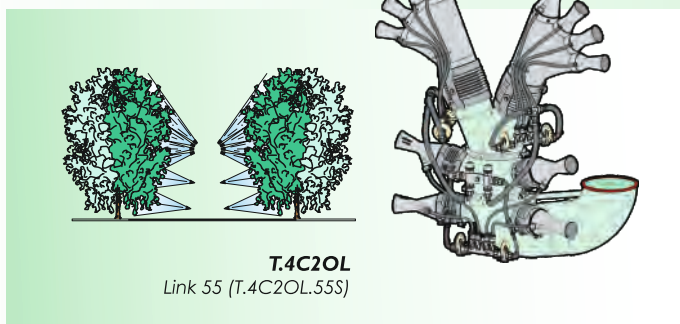

T.4C2OL
Link 55 (T.4C2OL.55S)

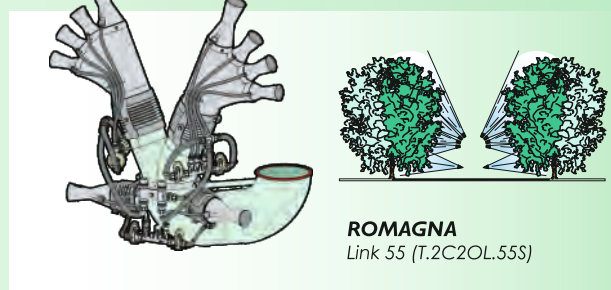

ROMAGNA
Link 55 (T.2C2OL.55S)

ACCESSORI - ACCESSOIRES

**KIT PISTONI IDRAULICI
KIT VERRINS HYDRAULIQUES**

disponibile per:
disponible pour:
T.4+4
T.5+5
T.OL

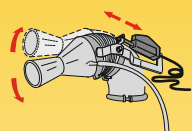
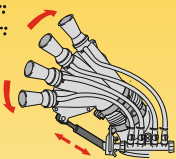

**KIT PISTONI ELETTRICI
KIT VERRINS ÉLECTRIQUES**
(solo cannoni superiori)
(seulement pour les canons supérieurs)



**GRUPPO 2 ELETTROVALVOLE SUPPLEMENTARI
GROUPE 2 ELECTROSOUPAPE ADDITIONNEL**
Link 50-55 (D.4E.P11)



**REGOLATORE ELETTRICO PRESSIONE
VANNE RÉGLAGE ÉLECTRIQUE DE LA PRESSION**
Link 50 - 55 (D.V.S01)

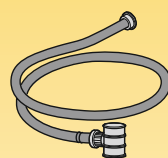

**TUBAZIONE RIEMPIMENTO
TUBULURE DE REMPLISSAGE**
Link (TUBAZ.RIEMP)



COLLARE - COLLIER
Link 50 D-175mm (X05.616.000)
Link 55 D-250mm (X05.813.000)



**SENSORI ULTRASUONI
CAPTEURS À ULTRASONS**
Link 50-55 (D.SU2.EPA.S02)



**KIT EASY FARM
KIT EASY FARM**
Link 50-55 (K.EASYFARM.01)

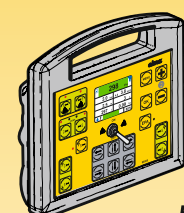

E.P.A. 2.0
Erogazione Proporzionale Avanzamento
Débit Proportionnel à l'Avancement
Link 50 - 55 (EPA.S11)

**KIT LUCI POSTERIORI
KIT FEUX ARRIÈRES**

Link 50-55 (KIT.LP.10.03)

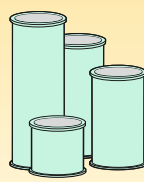
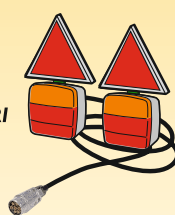

PROLUNGHE - RALLONGES
Link 50 D-175mm
200mm (X02.186.000) - 400mm (X02.187.000)
600mm (X02.188.000) - 800mm (X02.189.000)

Link 55 D-250mm
200mm (X21.100.020) - 400mm (X21.100.040)
600mm (X21.100.060) - 800mm (X21.100.080)

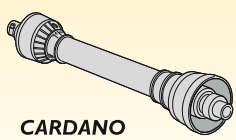

**CARDANO
CARDAN**
Link 50-55 (KHP.060.090)

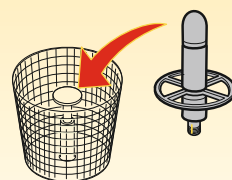

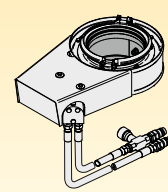

**LAVABARATTOLI
LAVE-BOÎTES**
(KIT.LAV.BOX)





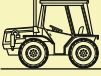
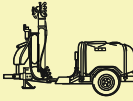

**GIREVOLE IDRAULICO
PIVOTANT HYDRAULIQUE**
Link 50 (T.GIR.I.175P)
Link 55 (T.GIR.I.250P)

Alcuni accessori sono forniti di serie in certi paesi - Certains accessoires sont fournis de série dans certains pays

INFORMAZIONI TECNICHE CARACTERISTIQUES TECHNIQUES

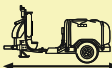
		Link 50 N	Link 50 S	Link 55 N	Link 55 S	Link 55 E
	TRATTRICE	potenza richiesta 48 kW - 65 CV	potenza richiesta 52 kW - 70 CV	potenza richiesta 52 kW - 70 CV	potenza richiesta 58 kW - 80 CV	potenza richiesta 66 kW - 90 CV
	TRACTEUR	puissance demandée 48 kW - 65 CV	puissance demandée 52 kW - 70 CV	puissance demandée 52 kW - 70 CV	puissance demandée 58 kW - 80 CV	required power 66 kW - 90 CV
	ATOMIZZATORE	potenza assorbita 24 kW - 33 CV	potenza assorbita 26 kW - 36 CV	potenza assorbita 26 kW - 36 CV	potenza assorbita 34 kW - 47 CV	potenza assorbita 41 kW - 55 CV
	PNEUMATIQUE	puissance absorbée 24 kW - 33 CV	puissance absorbée 34 kW - 47 CV	puissance absorbée 26 kW - 36 CV	puissance absorbée 34 kW - 47 CV	puissance absorbée 41 kW - 55 CV
		radiale in acciaio chiusa D.500 mm				
	VENTOLA	4000 giri/min. portata aria: 7550 m³/h velocità aria: 175 m/s	4210 giri/min. portata aria: 8300 m³/h velocità aria: 180 m/s	3500 giri/min. portata aria: 12500 m³/h velocità aria: 150 m/s	3700 giri/min. portata aria: 14000 m³/h velocità aria: 170 m/s	3900 giri/min. portata aria: 15500 m³/h velocità aria: 180 m/s
		diamètre 500 mm, fermée, en acier				
	TURBINE	4000 t/mn débit d'air: 7550 m³/h vitesse d'air: 175 m/s	4210 t/mn débit d'air: 8300 m³/h vitesse d'air: 180 m/s	3500 t/mn débit d'air: 12500 m³/h vitesse d'air: 150 m/s	3700 t/mn débit d'air: 14000 m³/h vitesse d'air: 170 m/s	3900 t/mn débit d'air: 15500 m³/h vitesse d'air: 180 m/s
	POMPA N: Normal - S: Super E: Extra	centrifuga di alimentazione e agitazione CIMA CD 32 - 4250 giri/min. portata massima 140 l/min. - pressione massima 4,5 kg/cm²				
	POMPE N: Normal - S: Super E: Extra	centrifuge CIMA CD 32 - 4250 t/mn débit 140 l/mn - pression max 4,5 kg/cm²				

Valori suscettibili di variazioni in funzione del dispositivo di distribuzione utilizzato
Valeurs indicatives qui peuvent changer en fonction de l'équipement de distribution utilisé.

		Link 50				Link 55			
		I. 800	I. 1000	I. 1000 stretto - étroit	I. 1500	I. 800	I. 1000	I. 1000 stretto - étroit	I. 1500
	LUNGHEZZA	322 cm	330 cm	322 cm	396 cm	322 cm	330 cm	322 cm	396 cm
	LONGUEUR								
	LARGHEZZA	109-135 cm	140-165 cm	113-139 cm	163-210 cm	109-135 cm	140-165 cm	113-139 cm	163-210 cm
	LARGEUR								
	ALTEZZA	169 cm	172 cm	169 cm	170 cm	169 cm	172 cm	169 cm	170 cm
	HAUTEUR								
	PESO	510 kg	540 kg	535 kg	668 kg	523 kg	553 kg	550 kg	683 kg
	POIDS								
	RUOTE	7.00-12	10/80-12	10/80-12	10/75-15,3	7.00-12	10/80-12	10/80-12	10/75-15,3
	ROUES	10/80-12 (opt.)	10/75-15,3 (opt.)	10/75-15,3 (opt.)		10/80-12 (opt.)	10/75-15,3 (opt.)	10/75-15,3 (opt.)	

Le dimensioni e pesi sono a titolo indicativo e possono variare secondo la configurazione della macchina
Les valeurs sont à titre indicatif et peuvent varier suivant la configuration de la machine

Nei paesi dell'Unione Europea le nostre attrezzature sono conformi alla Direttiva Europea "Macchine"; negli altri paesi sono conformi alle norme di sicurezza in vigore in quei paesi.



Dans les pays de l'Union Européenne, nos équipements sont conformes à la Directive Européenne "Machines"; dans les autres pays ils sont conformes aux prescriptions de sécurité en vigueur dans ces pays.

cima[®]



RIVENDITORE AUTORIZZATO - CONCESSIONAIRE

Loc. Molino Quaroni n.7, Montù Beccaria - PV - (ITALY)
Tel. +39.0385.246636 - www.cima.it

