

cima[®]

ATOMIZZATORI-IMPOLVERATORI

New Plus 42-45



**ATOMIZZATORI PNEUMATICI A BASSO VOLUME
PNEUMATIQUES PORTÉS**

New Plus 42 - 45



- ★ Telaio in acciaio, verniciatura elettrostatica con polvere poliestere e predisposto per applicare coppia ruote.
- ★ Cerchio di protezione delle testate.
- ★ Ventola centrifuga chiusa ad alta pressione, in acciaio, con disinnesto; carter in polietilene rotazionale.
- ★ Controllo dal posto operatore dell'erogazione con due elettrovalvole.



- ★ Châssis en acier avec peinture polyester électrostatique et adapté pour l'installation d'une paire de roues.
- ★ Pare-chocs à protection des équipements.
- ★ Turbine centrifuge fermée haute pression, en acier, débrayable dans volute en polyéthylène rotomoulée.
- ★ Contrôle du débit à télécommande électrique depuis le poste de conduite.



- ★ Regolatore di pressione manuale (a comando elettrico dal posto operatore a richiesta).
- ★ Manometro (ø100) ben visibile dal posto operatore.
- ★ Filtro di grande portata: 240 l/min.



- ★ Régulateur de pression manuel (en option télécommande électrique depuis le poste de conduite).



- ★ Manomètre (ø100), bien visible depuis le poste de conduite.
- ★ Filtre à grand débit: 240 l/min.

- ★ **La pompa centrifuga** di fabbricazione C.I.M.A. (senza membrane e valvole) costruita in materiale anticorrosivo è **esente da manutenzione**. La cinghia di trasmissione 3V è dotata di tenditore automatico.



- ★ **La pompe centrifuge** fabrication C.I.M.A. (sans membranes et clapets) produite en matériel anti-corrosion est **fiable et sans entretien**. Sa courroie de transmission 3V est équipée d'un tendeur automatique.



Atomizzatori - Pneumatiques



☆ Ampia scelta di testate di distribuzione, tutte dotate del nuovo sistema anti-sgocciolamento (brev. N° 1745689) e di dispositivi di diffusione (mani e/o cannoni) di diverse dimensioni, **adattabili in altezza, orientabili ed intercambiabili** per garantire, su tutte le tipologie di colture, un'eccellente copertura e penetrazione nella vegetazione.



☆ Large choix d'équipements de pulvérisation, tous équipés du nouveau système antigoutte (brevet No. 1745689) et des dispositifs de diffusion (mains et/ou canons) de dimensions différentes, **adaptables aux hauteurs, orientables et interchangeables**, pour garantir, à chaque type de culture, une meilleure pénétration et une couverture d'excellente qualité de la végétation.

☆ **Regolatori a disco rotante** con 15 fori calibrati (brev. N° 23238), sostituiscono il sistema a pastiglie. **Erogazione da 70 a 3400 litri/ora**

☆ **Régulateurs à disques tournants** avec 15 trous calibrés (brevet No. 23238) remplacent le système à pastilles. **Débit : de 70 à 3400 lh.**



☆ Serbatoio in polietilene rotazionale, apertura di riempimento di grandi dimensioni (Ø360) con coperchio a cerniera, indicatore di livello.

☆ Serbatoio lavamani integrato l. 15.

☆ Serbatoio lavaimpianto integrato nel serbatoio principale (versioni GOLD).

☆ **Idromiscelatore integrato nel filtro a tazza.**

☆ **Doppia agitazione, idraulica e pneumatica.**

☆ **Trasmissione a cinghia poly-V** che assorbe le sollecitazioni. **Funzionamento per oltre 5000 ore.** Il tenditore automatico evita lo slittamento e quindi l'usura. La qualità della polverizzazione resta inalterata nel tempo.

☆ **Ruota libera di sicurezza per arresto improvviso.**

☆ **Transmission à courroie poly-V** qui absorbe toutes tensions. **Plus de 5000 heures de fonctionnement.** Le tendeur automatique évite le glissement et l'usure. La qualité de la pulvérisation reste inaltérée longtemps.

☆ **Roue libre de sécurité en cas d'arrêt soudain de la PdF** (en option).

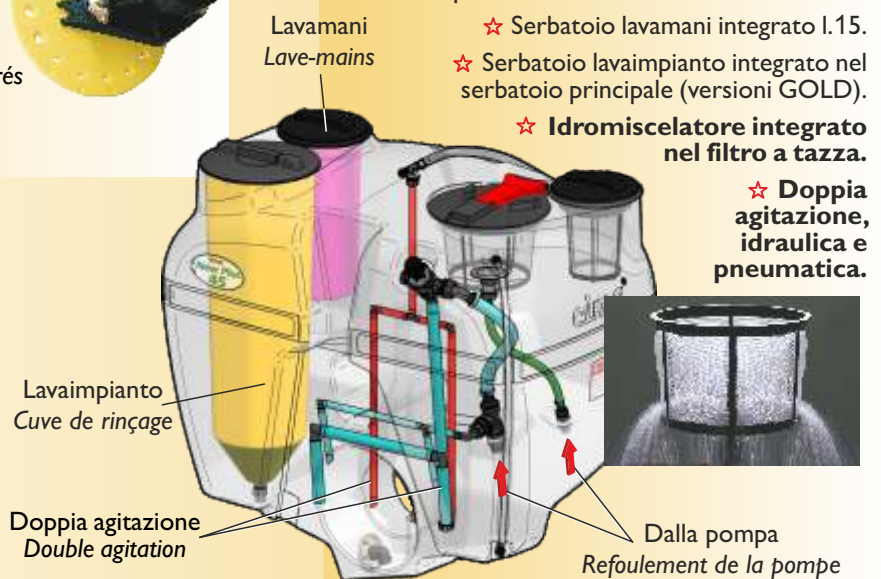

☆ Réservoir en polyéthylène rotomoulé. Large ouverture (Ø 360) avec couvercle à charnière, jauge graduée.

☆ Réservoir lave-mains intégré de 15 litres.

☆ Cuve de rinçage intégrée dans le réservoir principal (versions GOLD).

☆ **Tamis mélangeur intégré.**

☆ **Double agitation, hydro-pneumatique.**

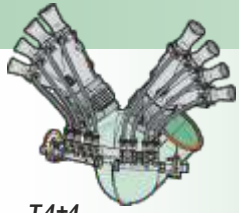

T.4+4

N.Plus 42 (T.4+4.42P)
N.Plus 45 (T.4+4.45P)

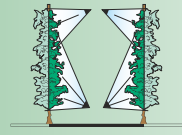
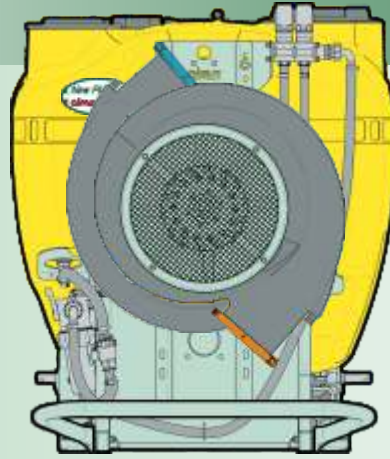
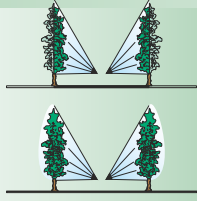

T.4M

N.Plus 42 (T.4M.42P)
N.Plus 45 (T.4M.45P)

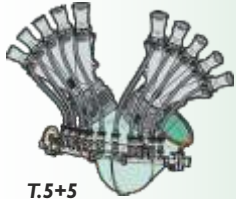
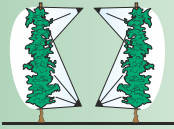
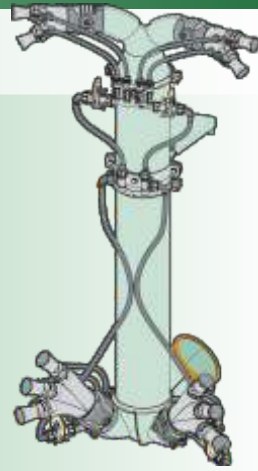

T.5+5

N.Plus 42 (T.5+5.42P)
N.Plus 45 (T.5+5.45P)

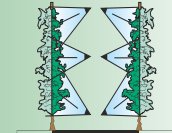
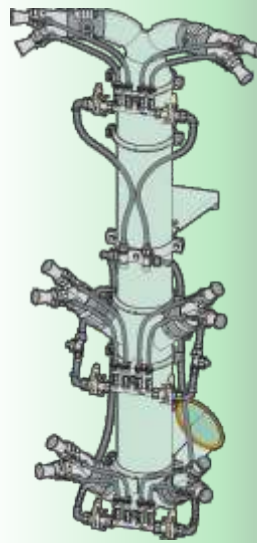
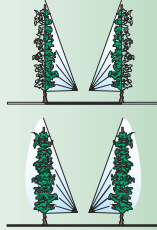

T.6M

N.Plus 42 (T.6M2D.42P)
N.Plus 45 (T.6M2D.45P)

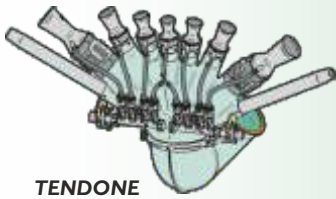
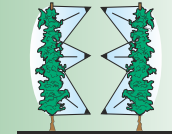

TENDONE

N.Plus 42 (T.TND.42P)
N.Plus 45 (T.TND.45P)

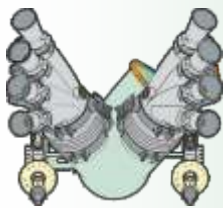
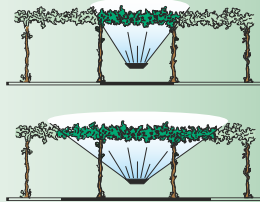

STRASBURGO - STRASBOURG

N.Plus 42 (T.ST4.42P)
N.Plus 45 (T.ST4.45P)

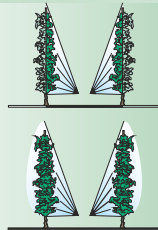

2 VENTAGLI - 2 ÉVENTAILS

N.Plus 42-45 (T.2V3S.45P)

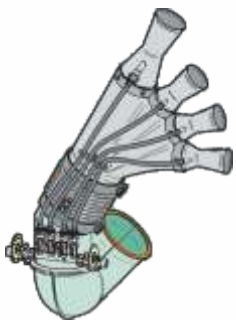
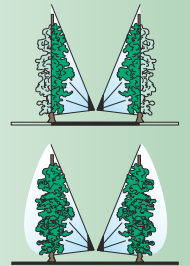

OLIVO - OLIVIER

N.Plus 42 (T.OL.42P)
N.Plus 45 (T.OL.45P)



OLIVO - OLIVIER

N.Plus 42 (T.OL.045.42)
N.Plus 45 (T.OL.045.45)

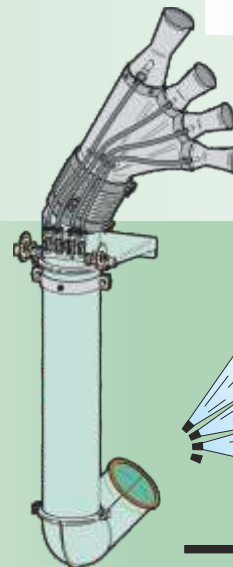
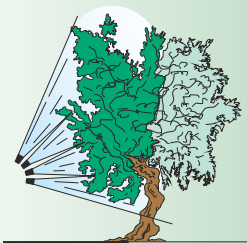

OLIVO - OLIVIER

N.Plus 42 (T.OL.P08.42)
N.Plus 45 (T.OL.P08.45)

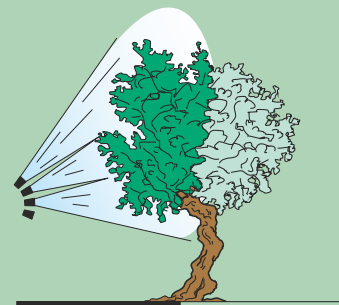

TESTATE

PER LE ZONE VENTOSE
 POUR LES ZONES VENTEUSES

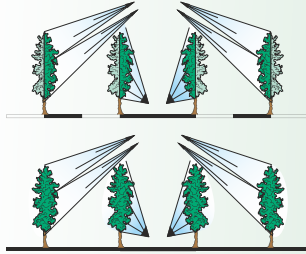

TCF.2M4C
 N.Plus 45 (TCF.2M4C.A45P)

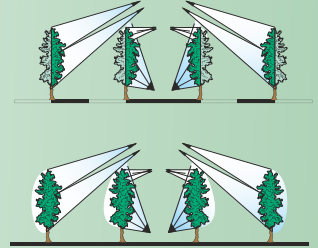
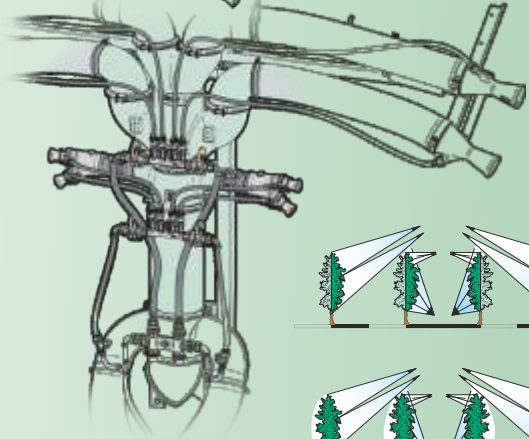

TCF.4M4C
 N.Plus 45 (TCF.4M4C.A45P)

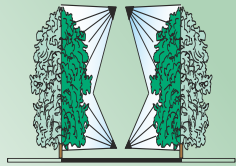
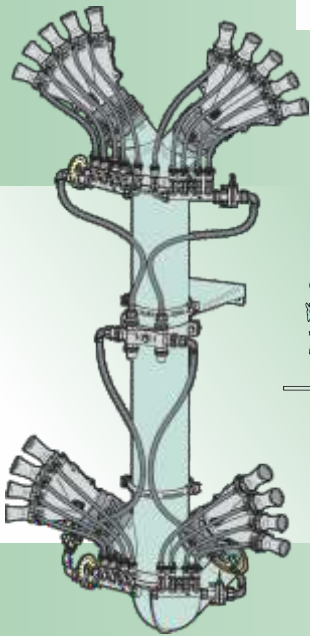

CAFFÈ - COFFEE
 Plus 45 (T.CA.45P)

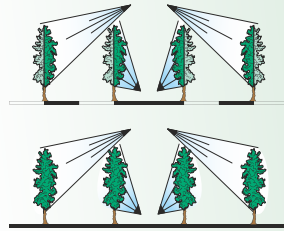

TCS.2M2C
 N.Plus 45 (TCS.2M2C.45P)

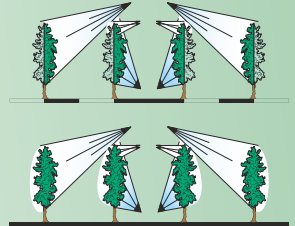
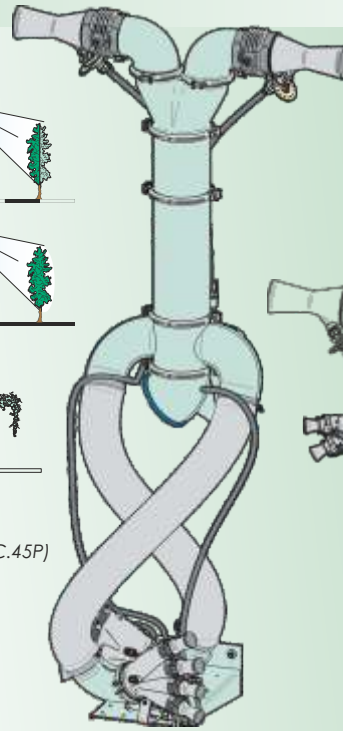

TCS.4M2C
 N.Plus 45 (TCS.4M2C.45P)

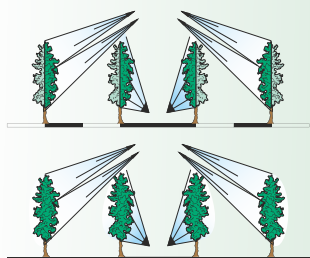
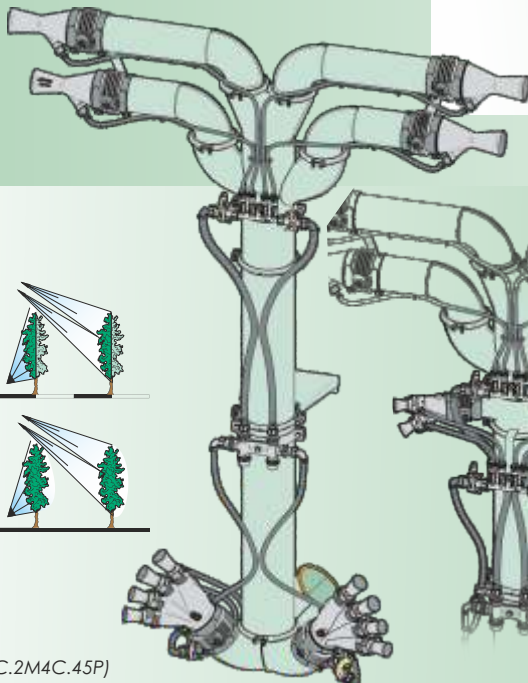

TC.2M4C
 N.PLUS 45 (TC.2M4C.45P)

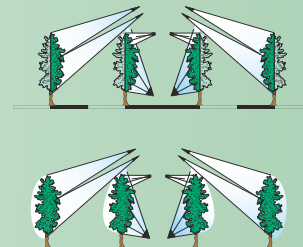

TC.4M4C
 N.PLUS 45 (TC.4M4C.45P)

DISTRIBUTION HEADS

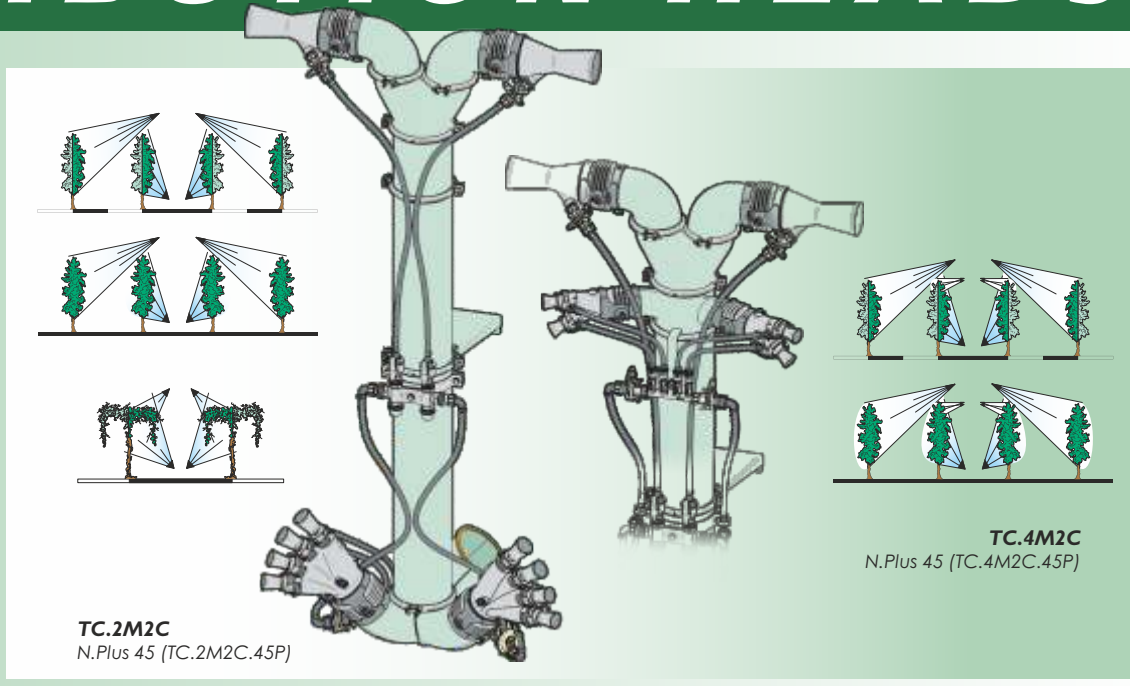

TC.2M2C
N.Plus 45 (TC.2M2C.45P)

TC.4M2C
N.Plus 45 (TC.4M2C.45P)

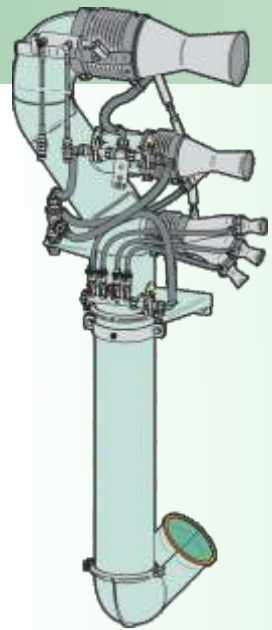

CANNONE - CANON
N.Plus 42 (T.GC.P08.42)
N.Plus 45 (T.GC.P08.45)

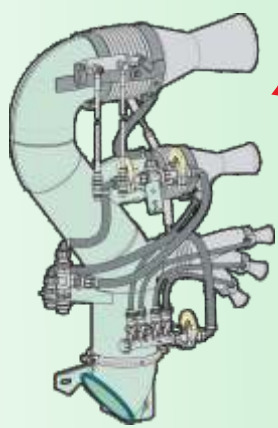

CANNONE - CANON
N.Plus 42 (T.GC.045.42)
N.Plus 45 (T.GC.045.45)

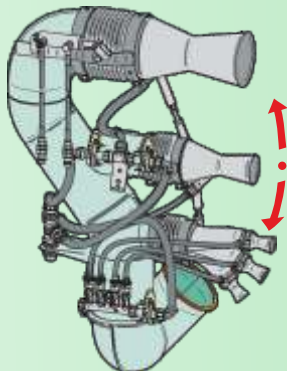

CANNONE - CANON
N.Plus 42 (T.GC.42P)
N.Plus 45 (T.GC.45P)

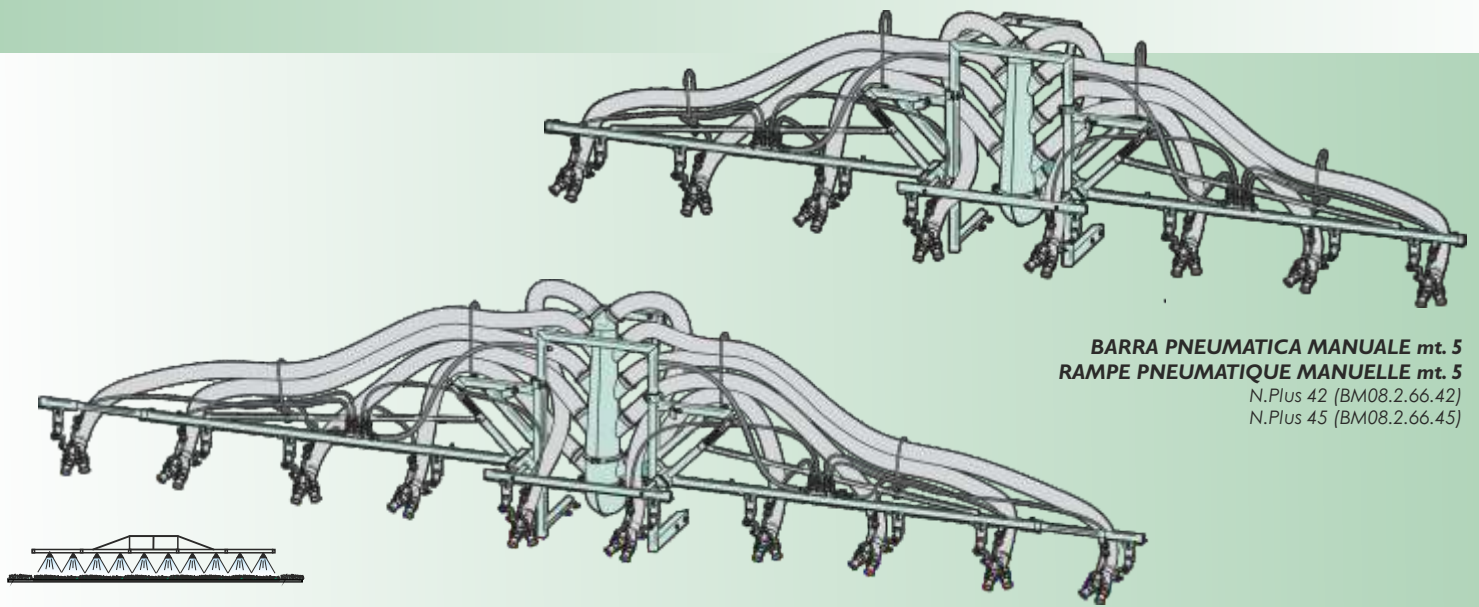
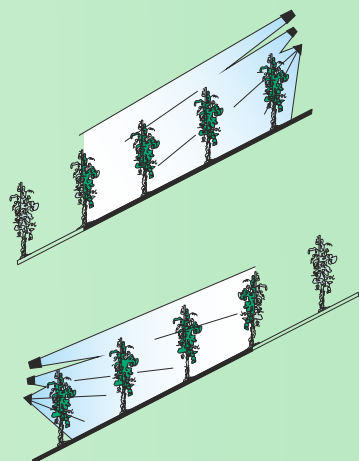

BARRA PNEUMATICA MANUALE mt. 5
RAMPE PNEUMATIQUE MANUELLE mt. 5
N.Plus 42 (BM08.2.66.42)
N.Plus 45 (BM08.2.66.45)

BARRA PNEUMATICA MANUALE mt. 7
RAMPE PNEUMATIQUE MANUELLE mt. 7
N.Plus 45 (BM10.2.66.45)

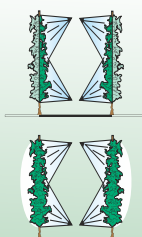
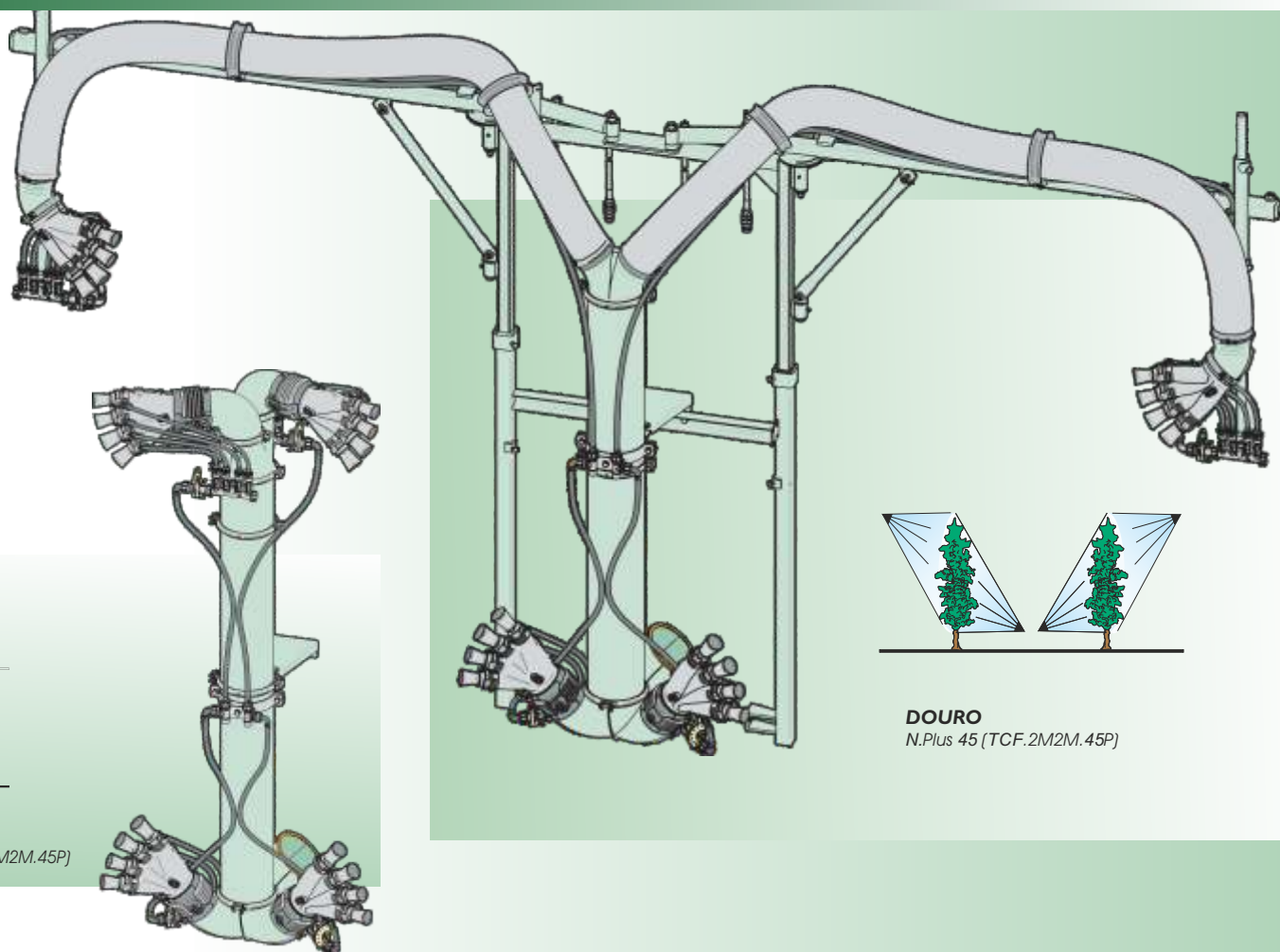

TC.2M2M
N.Plus 45 (TC.2M2M.45P)

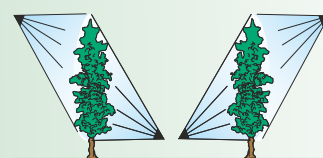

DOURO
N.Plus 45 (TCF.2M2M.45P)

ACCESSORI - ACCESSOIRES

KIT PISTONI IDRAULICI KIT VERRINS HYDRAULIQUES

disponibile per:
disponible pour:

T. 4+4
T. 5+5
T.OL

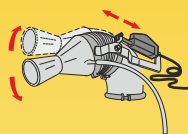
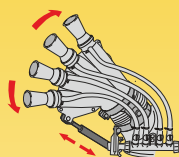

KIT PISTONI ELETTRICI (solo cannoni superiori)

KIT VERRINS ÉLECTRIQUES
(seulement pour les canons supérieurs)

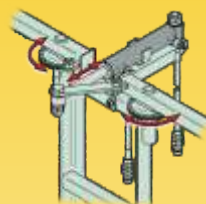

KIT IDRAULICO CHIUSURA BRACCI TCF KIT HYDRAULIQUE FERMETURE DES BRAS EQUIPEMENTS TCF

N. Plus 45 (K.2.TCF.A01)



REGOLATORE ELETTRICO PRESSIONE VANNE RÉGLAGE ÉLECTRIQUE DE LA PRESSION

N. Plus 42-45 (D.V.P01)

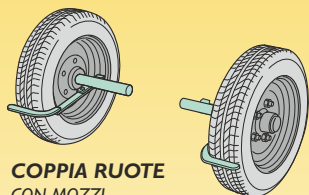

COPPIA RUOTE CON MOZZI PAIRE DE ROUES AVEC MOYEUX

N.Plus 42-45 (T.CPP.RT.01)

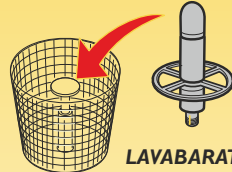

LAVABARATTOLI LAV' BOX (KIT.LAV.BOX)

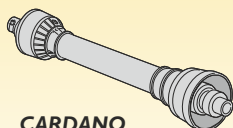

CARDANO ARBRE CARDAN

N. Plus 42 (KHP.040.090)
N. Plus 45 (KHP.050.090)

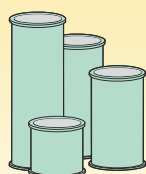

PROLUNGHE - RALLONGES

N.Plus 42-45 D-175mm
200mm (X02.186.000) - 400mm (X02.187.000)
600mm (X02.188.000) - 800mm (X02.189.000)



COLLARE - COLLIER D-175mm (X05.616.000)

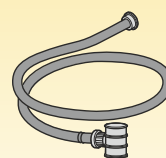

TUBAZIONE RIEMPIMENTO TUBULURE DE REMPLISSAGE

N. Plus 42-45 (TUBAZ.RIEMP)



GRUPPO 4 ELETTROVALVOLE GROUPE 4 ÉLECTROVANNES

N. Plus 42-45 (D.4E.P01)



GIREVOLE MANUALE PIVOTANT MANUEL

N.Plus 42-45 (T.GIR.M.175P)

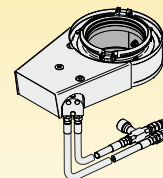





GIREVOLE IDRAULICO PIVOTANT HYDRAULIQUE

N.Plus 42-45 (T.GIR.I.175P)

Alcuni accessori sono forniti di serie in certi paesi - Certains accessoires sont fournis de série dans certains pays

INFORMAZIONI TECNICHE

CARACTERISTIQUES TECHNIQUES

		New Plus 42	New Plus 45
	TRATTRICE	potenza richiesta 18 kW - 25 CV	potenza richiesta 33 kW - 45 CV
	TRACTEUR	puissance demandée 18 kW - 25 CV	puissance demandée 33 kW - 45 CV
	ATOMIZZATORE	potenza assorbita 13 kW - 18 CV	potenza assorbita 17 kW - 23 CV
	PNEUMATIQUE	puissance absorbée 13 kW - 18 CV	puissance absorbée 17 kW - 23 CV
	VENTOLA	radiale in acciaio chiusa D.450 mm 4000 giri/min. portata aria: 4000 m ³ /h velocità aria: 228 m/s	radiale in acciaio chiusa 450 mm 4500 giri/min. portata aria: 5400 m ³ /h velocità aria: 188 m/s
	TURBINE	diamètre 450 mm, fermée, en acier 4000 t/mn débit d'air: 4000 m ³ /h - vitesse d'air: 228 m/s	diamètre 450 mm, fermée, en acier 4500 t/mn débit d'air: 5400 m ³ /h - vitesse d'air: 188 m/s
	POMPA	centrifuga di alimentazione e agitazione CIMA CD 32 - 4000 giri/min. portata 120 l/min. - pressione massima 4,5 kg/cm ²	centrifuga di alimentazione e agitazione CIMA CD 32 - 4250 giri/min. portata 140 l/min. - pressione massima 4,5 kg/cm ²
	POMPE	centrifuge CIMA CD 32 - 4000 t/mn débit 120 l/mn - pression max 4,5 kg/cm ²	centrifuge CIMA CD 32 - 4250 t/mn débit 140 l/mn - pression max 4,5 kg/cm ²

Valori suscettibili di variazioni in funzione del dispositivo di distribuzione utilizzato
Valeurs indicatives qui peuvent changer en fonction de l'équipement de distribution utilisé.

DIMENSIONI E PESO - DIMENSIONS ET POIDS

		New Plus 42-45		New Plus Gold 42-45	
		I. 300	I. 400	I. 300	I. 400
	LUNGHEZZA	144-162 cm	144-162 cm	144-162 cm	144-162 cm
	LONGUEUR				
	LARGHEZZA	96 cm	112 cm	96 cm	112 cm
	LARGEUR				
	ALTEZZA	119 cm	122 cm	127 cm	130 cm
	HAUTEUR				
	PESO	42: 208 kg	42: 211 kg	42: 216 kg	42: 219 kg
	POIDS	45: 210 kg	45: 213 kg	45: 218 kg	45: 221 kg

Il peso indicato è calcolato a vuoto SENZA il dispositivo di distribuzione e SENZA gli accessori eventualmente installati.
I valori sono riportati a titolo indicativo e possono variare secondo la configurazione della macchina
Le poids indiqué est calculé à vide SANS le dispositif de distribution et SANS les accessoires installés.
Les valeurs sont à titre indicatif et peuvent varier suivant la configuration de la machine

Nei paesi dell'Unione Europea le nostre attrezzature sono conformi alla Direttiva Europea "Macchine"; negli altri paesi sono conformi alle norme di sicurezza in vigore in quei paesi.



Dans les pays de l'Union Européenne, nos équipements sont conformes à la Directive Européenne "Machines"; dans les autres pays ils sont conformes aux prescriptions de sécurité en vigueur dans ces pays.

cima[®]



RIVENDITORE AUTORIZZATO - CONCESSIONAIRE

Loc. Molino Quaroni n.7, Montù Beccaria - PV - (ITALY)
Tel. +39.0385.246636 - www.cima.it

